

User guide
January

98

Magelis range XBT-H/P/E/HM Tome 1

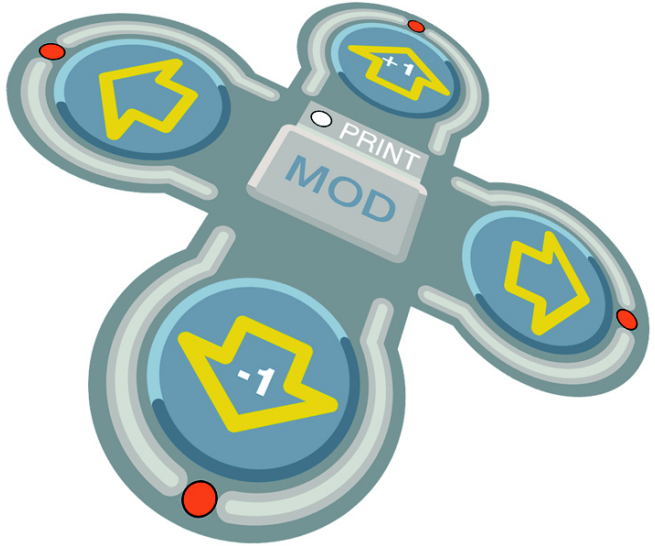

GROUPE SCHNEIDER

■ Merlin Gerin ■ Modicon ■ Square D ■ Telemecanique

For a minimum size dialogue
application, refer to
Sections A and B



If you are not familiar with man/machine dialogue using a Magelis terminal, start at Section.

Introduction

A

If you want to set up a Magelis application as an example, read Section.

Example of using a Magelis application

B

If you are an XBT expert and you want to learn about the Magelis functions, read Section.

Magelis functions

C

If you are a PLC programmer and you want to become acquainted with PLC/Magelis dialogue, read Section.

PLC/Magelis terminal dialogue

D

If you want information about your Magelis terminal, read Section.

Detailed characteristics of Magelis terminals

E

If you have a terminology problem, turn to Section.

Glossary

F

If you want to find a specific piece of information, consult Section.

Index

G

If you have any problems, consult the index at the end of the document.

Error messages

H



Pictograms used in the document



ATTENTION sign

Marks important procedures (during installation, use or modification).



"EXAMPLE" sign

Marks practical examples (entry techniques, etc).

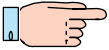

HAND

Marks general points, notes, etc.



————— **Section A** —————

Introduction

This Section covers with the following topics :

1. Man/machine dialogue with Magelis	A-5
2. Structure of Magelis applications.....	A-7
3. Application pages	A-14
4. Alarm pages.....	A-16
5. Terminal operating modes	A-18
6. Controlling the control system	A-19
7. Dialogue between the PLC and the terminal ...	A-20
8. Control system production file	A-22
9. General characteristics of the terminals.....	A-23

1. Man/machine dialogue with Magelis

The main functions of Magelis terminals are to :

- **Display** data from the control system,
- **Modify** the control system parameters,
- **Control** the process using discrete commands.

Display data from the control system
Signal control system faults

Programming the terminal with XBT-L1000



Indicator lamps
-communication status
-key strokes enabled

Control the control system

Modify the control system parameters

Record and time-stamp the occurrence of control system alarm

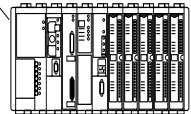
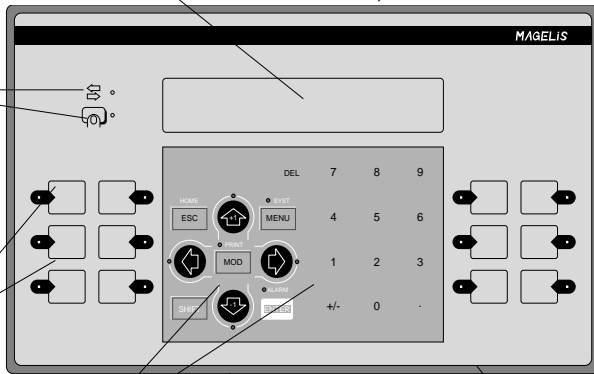

Communicate with the control system :
Telemecanique, April, Modicon, Siemens, etc, PLCs.

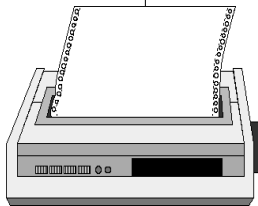

- Print fault log
- Print production data

The applications associated with Magelis can be :

Production monitoring

Display process status messages :

Automatic operation
Start hydraulic unit
End of lift of manipulator
Rotation of grip to right

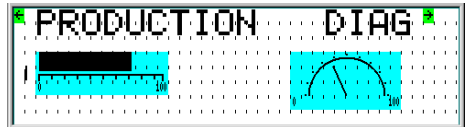

Preventive maintenance

Counting parts for production monitoring :

Type 1 housing : 7555
Base unit : 1200

Counting with indication if threshold exceeded :

Number of drillings 3137
Change tool at 4000

Corrective maintenance

Indication of process faults :

Oil level too low
Door open

Process control

Process control via configurable function keys :

Pressurizing P
Start Cycle SC



Modification of the process parameters :

Level 1: 556
Limit n12 : 725

2. Structure of Magelis applications

A Magelis application is the entire dialogue between the user and the automated process. This consists of :

- . criteria linked to the control system :
 - production monitoring,
 - preventive maintenance,
 - corrective maintenance,
 - process control.
- . criteria concerning the user :
 - user interface,
 - level of involvement.
- . criteria concerning setting up the dialogue application itself
 - programming,
 - debugging,
 - updating.

These characteristics mean that **your application must be structured. An application will consist of a series of pages, which can form a tree structure**, as in the diagram below :

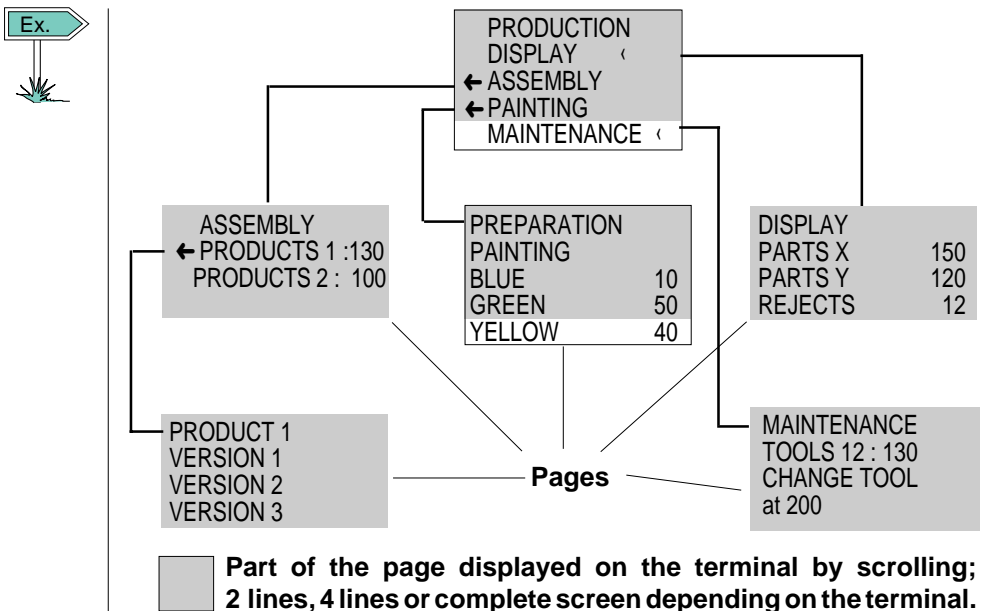

2.1. Terminals with 2 or 4 lines

Page

- A page can contain a **maximum of 25 lines**.
- The length of the lines on each page depends on the capacity of the MAGELIS terminal. The number of lines on each page, displayed during operation, depends on the capacity of the Magelis terminal :
 - 2*20 characters**
 - 2*40 characters**
 - 4*40 characters**
- A page is displayed as follows :

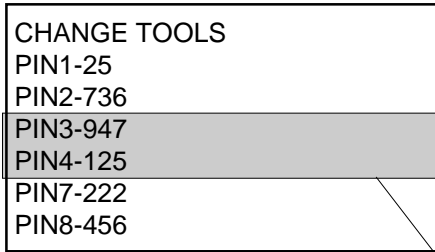

The arrow keys are used to scroll the lines on the page.

Lines on the page displayed on the display unit, 2 or 4 lines depending on the terminal.

- A page is identified by a **number** and a **name** (optional). The page can then be displayed on the terminal by commands from the terminal or the PLC.
- Access to pages can be protected by a password.
- Section F gives the technical characteristics of the various Magelis terminals.
- The PC software, **XBT- L1000**, is used to create dialogue pages.
- Two types of page can be used :
 - application pages**
 - alarm pages**

Line

- Each line consists of **alphanumeric text** and can include :
 - **variable fields**, that is zones for :
 - either the display of values reflecting the status of the control system : status of a bit, of a single or double word, of a floating point word, or an ASCII string.
 - or the entry of parameters for operating the control system : modification of bits, single or double words, floating point words, or an ASCII string.

A line can contain several fields.

The display format can be binary, decimal, hexadecimal, floating point or alphanumeric.

- **links** enabling access to other dialogue pages via the



keys (depending on the type of terminal)



Dialogue lines to indicate a repair procedure :

```
REPAIR
LOCK THE AXIS AT ZERO POSITION
CHANGE TO MANUAL
CHANGE THE PART
```

Dialogue lines with variable fields :

```
LEVEL 1          556
LIMIT 12         725
```

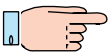
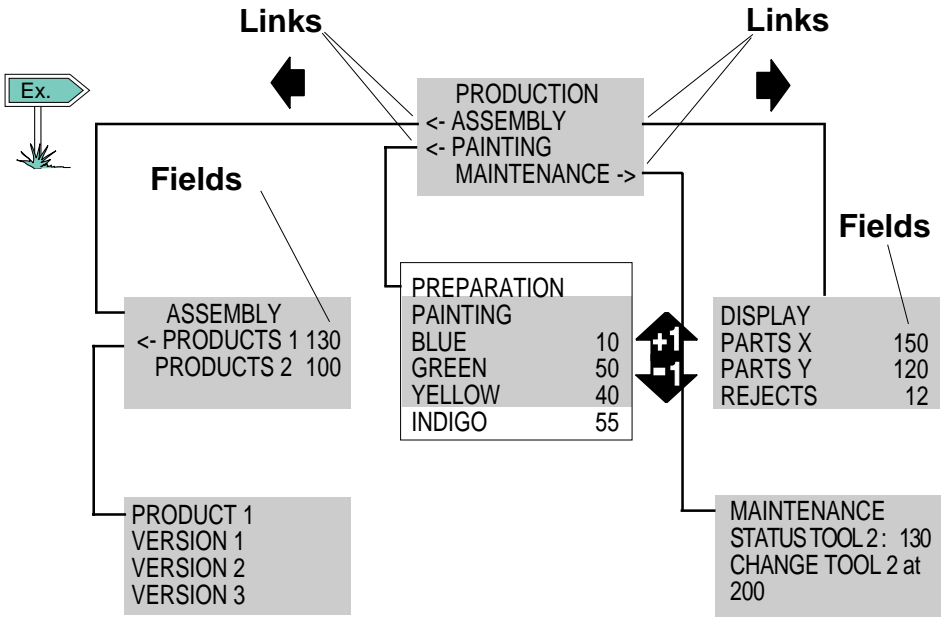

You can manage your own man/machine dialogue application with the page numbers alone and with no links.

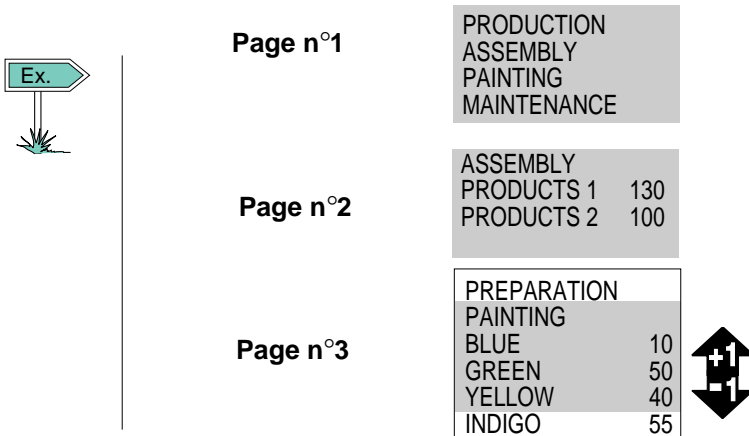

2.2. Matrix screen terminals

Page The display equipping the XBT-HM terminals is an LCD mono-chrome screen with a display capacity of 8 x 40 characters. With double height, double width and double size character facility, the respective capacities are :

- 8 x 40 characters
- 4 x 40 characters
- 8 x 20 characters
- 4 x 20 characters

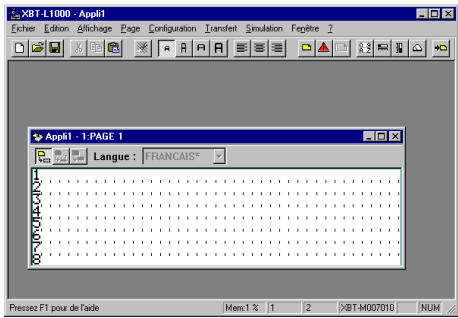

Each page can include the following features :

- **a background image** with the same size as the screen and associated to each application page.
- **alphanumeric text** with the following properties and sizes :

- . Single size
- . Double width
- . Double height
- . Double size



It is possible to have different size characters on the same line of text.

- **variable fields** used :

- either to display values reflecting the status of the control system : status of a bit, of a single or double word, of a floating point word, or an ASCII string.
- or to enter parameters for operating the control system : modification of bits, single or double words, floating point words, or an ASCII string.

The display format can be binary, decimal, hexadecimal, floating point or alphanumeric.

- **links** giving the operator the possibility of directly displaying other pages using the arrow keys (direct link).

- **dynamic graphic objects** of the "indicator" type enabling graphic representation of the control system data

Bar graph object



Used to provide a graphic representation of the control system data (e.g. level in a tank).

Parameters to be defined

Reference of the variable associated with the object.

Format: 16 bit signed or unsigned word.

Type of bar graph:

- Vertical (single size or double size)
- Horizontal (single size or double size)

Min/max limit exceeded, indicated by flashing display.

The min/max values are those seen by the operator, in other words after conversion.

Conversion factor

For further information, refer to the XBT L1000 software on-line help.

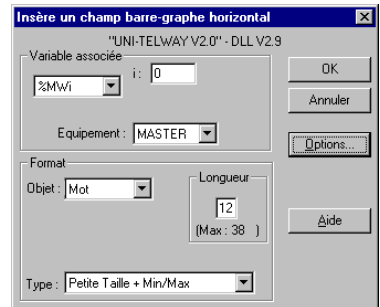

Meter object

Used to provide a graphic representation of the control system data (e.g. supply voltage monitoring)

Parameters to be defined

Reference of the variable associated with the object.

Format: 16 bit signed or unsigned word

Minimum, maximum limits.
Min/max limit exceeded, indicated by flashing display

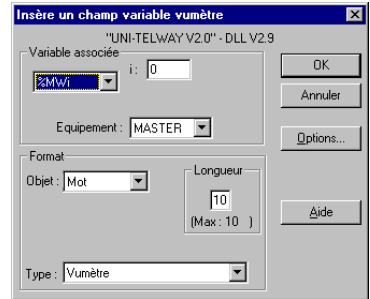

For further information, refer to the XBT L1000 software on-line help.

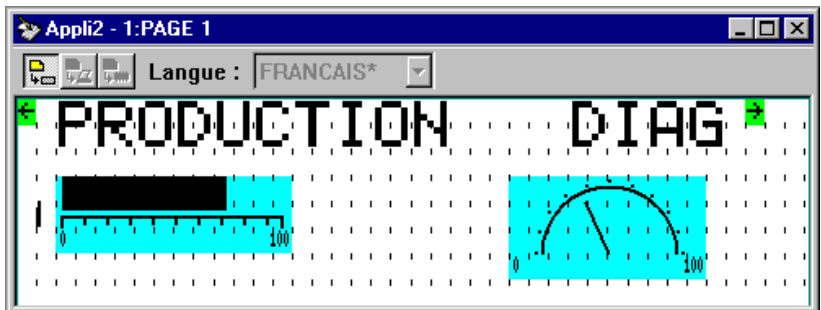

- A page is identified by **a number, a name** (optional)
- The pages are called up by pressing the function keys, by the PLC.
- The arrow keys are used to navigate within a page.
- The pages are defined using the XBT-L1000 programming software, and saved in the terminal.

3. Application pages

Application pages are for :

- Monitoring the control system.
- Performing operations on the control system.
- Maintaining the control system.

Application pages can be displayed (depending on the type of terminal) either :

- initiated by the control system (1),
- by configurable function keys (2),
- from a menu (3),
- from their name or number (4).

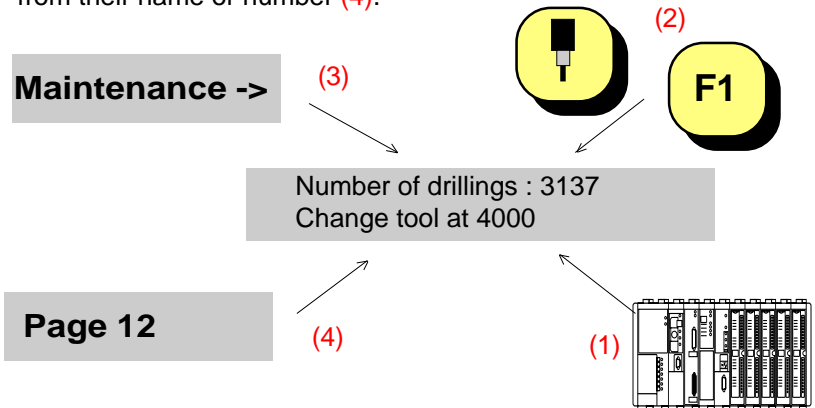

Application pages form the basic architecture of the dialogue.

Structuring the series of pages

It is advisable to organize the application pages into a menu format to reflect the stages in the **machine cycle**.

On every line of an application page, it is possible to create a link towards the right (->) and a link towards the left(<-). Each link gives access to another application page via the arrow keys.



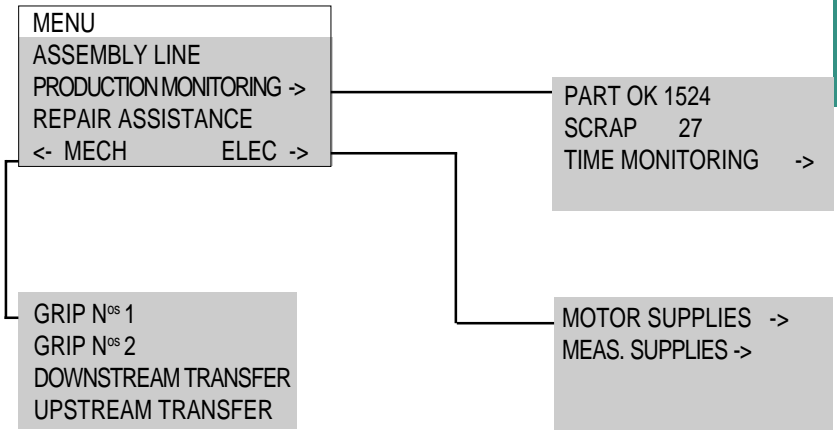

The indicator lamps for the ◀ and ▶ keys, managed by the terminal, show the operator whether a page can be displayed by pressing the corresponding key.

An active line (line on which the cursor is located) signals the access to another page by displaying the -> and/or <- characters in reverse video.

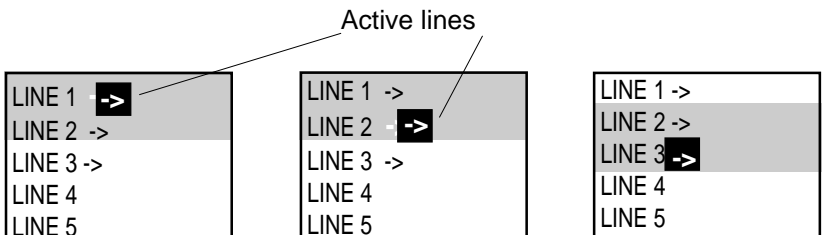

4. Alarm pages

An alarm page has the same characteristics as an application page with regard to :

- the text,
- the fields.

The additional feature of an alarm page is its event-triggered display. The control system's word bit is assigned to each alarm page. If the word bit is at state 1, the page is displayed.



A sensor fault occurs. The bit associated with the sensor fault changes to 1 in the control system.

Sensor fault



ATTENTION PRESSURE SENSOR FAULT
CHANGE TO MANUAL

Entry in a variable field is not possible on an alarm page.
On the XBT-HM terminals, in the event of an alarm, the background image and the first line flash.

Advantages of alarm pages



- Display of an alarm page takes priority over an application page.
- It is possible to assign priority to an alarm page (0 to 16).
- It is possible to record (log) alarm pages to help with trouble shooting in the control system.
- The alarms are time-stamped.
- It is possible to force the operator to acknowledge alarms before continuing process operation ; this is useful when an alarm is transient.
- Magelis XBT-E terminals have a relay output whose contact is closed when an alarm page appears. This function can be configured by the user for each alarm page.

5. Terminal operating modes

Magelis terminals have 3 operating modes :

- **Recording mode** enabling Magelis terminal and XBT-L1000 exchanges.
- **Running mode** enabling the terminal connected to the control system in order to control it.
- **Confidential mode** (except XBT-H and XBT-HM) enabling, in addition to the functions of running mode, access by password to privileged functions (log, recipe, etc).

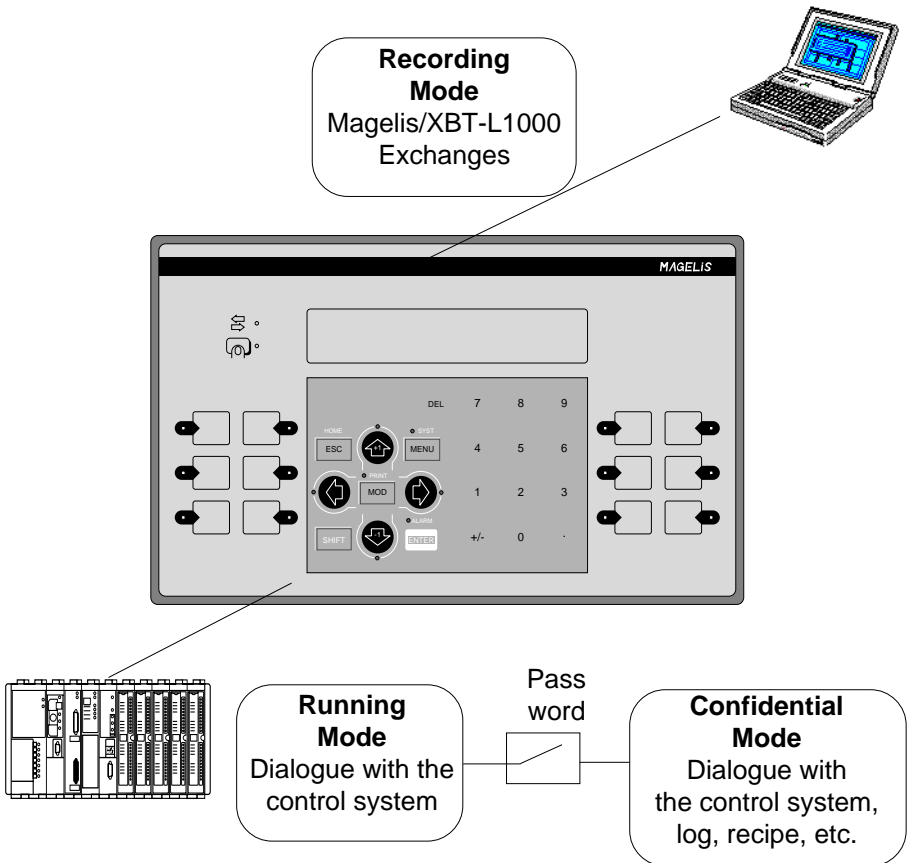

6. Controlling the control system

Magelis terminals allow the control system to be commanded by function keys. Two types of command are possible :

Momentary contact command

By pressing a function key, the control system's bit is activated ; the action stops when the key is released.



Controlling a motor

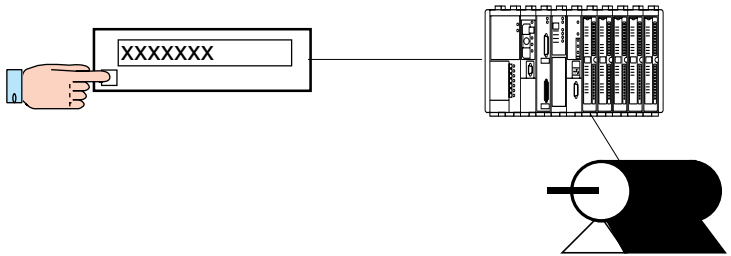

Push-on/push-off toggle command

The control system is activated by pressing the function key. The action is halted by pressing the function key again.



Command to advance a conveyor belt.

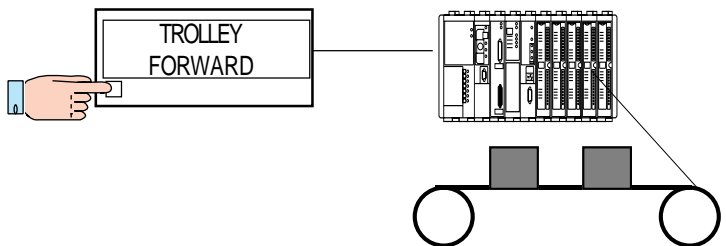

XBT-L1000 software can be used to assign the desired command to each function key.

7. Dialogue between the PLC and the terminal

The man/machine dialogue between the Magelis terminal and the PLC consists of an exchange of data between the two devices. Different types of data can be exchanged.

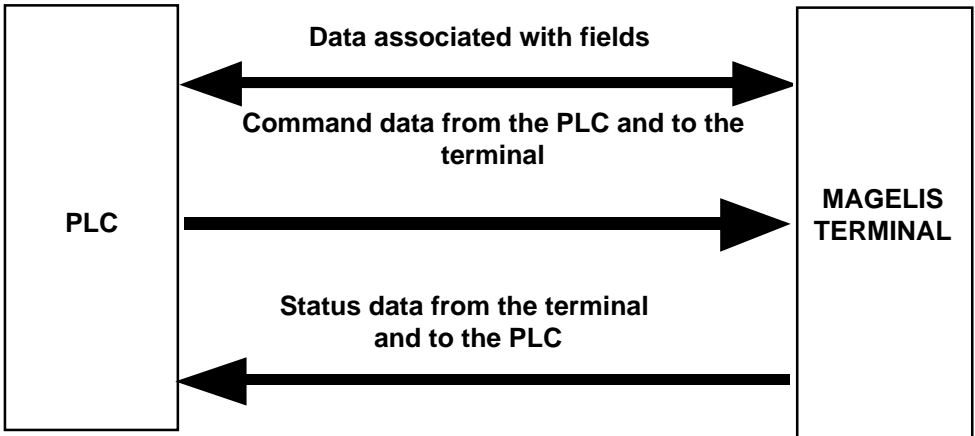

7.1. Data associated with the fields

The principle of the data exchanges associated with the fields depends on the protocol chosen which in turn depends on the type of PLC

Whether the terminal is master or client of the dialogue, it takes charge of the exchanges :

- updating the fields (reading the values in the PLC)
- entry and modification of fields (writing the values to the PLC)

In many instances, no PLC communication program needs to be written.

7.2. Principle of terminal "command and status" exchanges

A

To simplify the dialogue the data are grouped together in a table : **the dialogue table located in the PLC.**

- Commands from the PLC and to the terminal
- Status data from the terminal and to the PLC

Consisting of n consecutive words (words of 16 bits), this table has two parts

Status table Status data from the terminal and to the PLC
Command table Commands from the PLC and to the terminal

The number of words in the table depends on the choice of status data and the commands the user wishes to process via the dialogue. The XBT-L1000 software is used to make this choice.

8. Control system production file

Some Magelis terminals enable a "production file" to be printed based on the data from :

- application pages
- alarm pages (log)

The application and alarm pages are printed and time-stamped, and the contents of the fields indicated.

The alarm log pages are printed and the occurrence of faults is time-stamped, but there is no indication of the content of the fields

The print command can be initiated by :

- pressing the PRINT button on the terminal
- the PLC

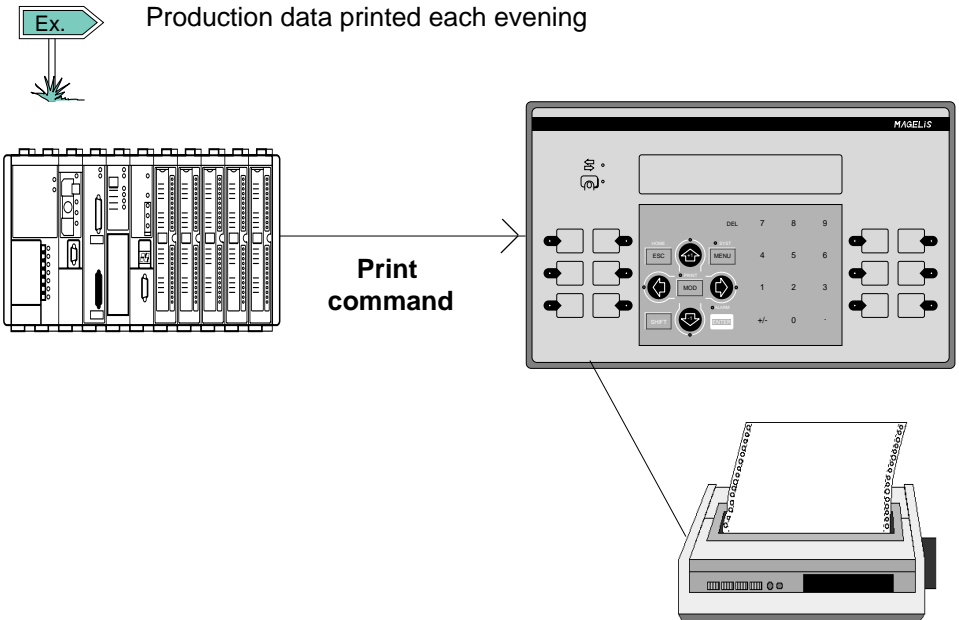

9. General specifications

This section gives the general characteristics of Magelis terminals. Section E gives the detailed characteristics of each terminal.

A

Power supply	24V DC Voltage limits : 18 to 30 V DC Ripple : 5 % maximum XBT-H811050 is supplied by TSX07 (use XBT-Z968 - 03 cable).
Memories	Application : FLASH EEPROM Fault log : battery backed RAM Recipe: battery backed RAM
Communication protocols	Multi-protocol, protocol can be downloaded by diskette using XBT-L1000 software
Number of application pages (*1)	For 2 lines per page and 2 variables per page: XBT-H8: 100 XBT-H : 200 XBT-HM:300 XBT-P : 400 XBT-E : 800
Number of alarm pages (*1)	256 (for 2 lines per page) 128 for XBT-H8 XBT-HM
Display	<ul style="list-style-type: none"> • LCD or fluorescent • 2 to 4 lines, 20 to 40 characters per line • Matrix LCD monochrome
Keypad	Customizable membrane keypad
Signalling	1 communication status indicator lamp 1 indicator lamp per function key, the display of which is controlled by the PLC program 1 indicator lamp per service key : this indicator lamp is lit up if the key is accessible 1 keypad use indicator lamp XBT-H8: no indicator lamp.
Real-time clock, relay, buzzer	XBT-E

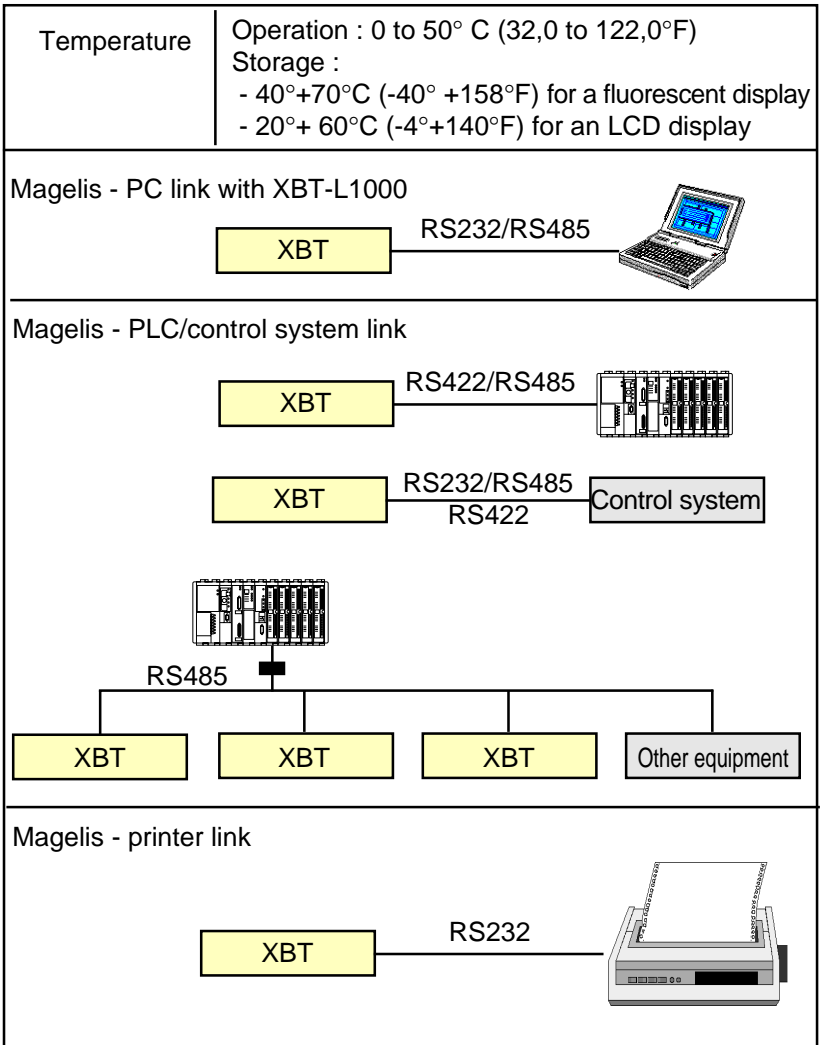

(*1) The XBT-L1000 software shows, as a percentage, when the application is created, the level of occupation of the application depending on the type of terminal. For more information on the number of pages, please consult Section E.

Section B

Example of setting up a Magelis application



The objective of the example is to guide you quickly through your first application.

Section C will give you all the information about the various operations performed.



1. Contents of the application

This application is suitable for any XBT Magelis with a display which has 20 characters per line, and an entry keypad.
It consists of : 2 application pages and 1 alarm page.

Page 1

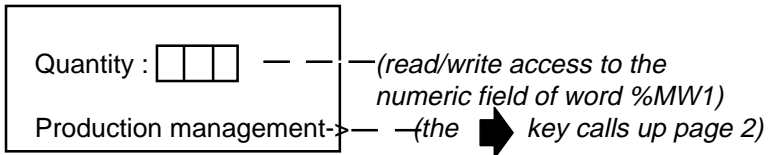

Page 2

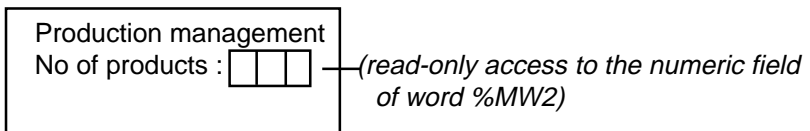

Alarm 1

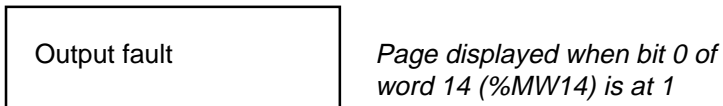

For this application, the designer wants the PLC to request the display of an application page, light the function key LEDs and use the function key states (if the Magelis terminal used has them).

Composition of the dialogue table (see chapter A § 7.2) between the terminal and the PLC

Word10 : Function keys

Word11 : Page number to process

Word12 : Authorisation

Word13 : LED commands

Word14 : Alarm table

The word syntax depends on the protocol used (example : UNI-TE "V2.0" protocol -> word 10=%MW10). The terminal will be able to write these words if the value of word 12 (authorisation) is equal in hexadecimal to H'A505' (05 = length of the table).

2. Creation of an application using XBT-L1000

1. Start up XBL-L1000 software.
2. Open new application by clicking on the icon
3. Select the **XBT type** (example : XBT-P022010).
4. Select the **protocol** (example : UNITELWAY V2.0) and confirm with OK
5. When the page editor displays page 1, enter the text of this page :

Quantity :

- To enter the accented characters :
 - select **Edit/Insert characters**,
 - double click on the character to be inserted,
 - click on copy (the character is placed onto the clipboard),
 - close the dialogue box then click on the  **Paste** icon (or CTRL+V), the character is inserted where the cursor is located.

To create a variable field :

- click on the  (0..9, A..Z) icon.
- modify the word number by entering 1 in the "i" field for the word %MW1,
- modify the field length (example : 3),
- confirm with OK.

Enter the following line

Production management->

To create a link with page 2 :

- click on the  icon (links to the right by default),
- confirm the dialogue box "Create link" with OK
- confirm with OK, the default page number in the window "New application page".

6. Click on "Page 2" in the "Page tree" window in order to enter the contents of page 2.

Production management

No of products :

- To create the variable field :

- click on the  (0..9, A..Z) icon.
- modify the word number by entering 2 in the "i" field for word %MW2,
- modify the field length (example : 3),
- click on **Options**,
- select **Read** in the "access" zone and confirm with OK
- confirm the insertion of the field with OK.

6. Click on the  icon to make the "New alarm page" window appear, click on OK to associate the page to bit 0 (selected by default) of the first alarm word n+0 (the word number will be assigned subsequently during configuration of the dialogue page).

7. The window "Appli1-1:ALARM 1" is displayed.

Once the first line of this page has been created and reserved for time-stamping the alarms, enter the alarm text from line 2.

Output fault

8. Select the **Configuration/Terminal parameters** menu.

To display page 1 when the terminal is started up :

- Deselect **system page**, select **Application Page**
- Click on **1: page1**. to select page 1
- Check that the language selected is correct and confirm with OK.

9. **Configuration of the dialogue table.**

- Select the **Configuration/Dialogue table** menu
- Click on **Number of displayed page** in the "Dialogue table" zone, then **Delete**.
- To declare the start address of the PLC dialogue table, click on **Modify** in the address zone, enter 10 in the " i" field (start of the dialogue table in %MW10) and confirm with OK.

10. Confirm with OK.

- To assign a word to the display of the alarm page, click on **Alarm table** in the "Dialogue table" zone, then enter 1 in the "Selected function size" zone and confirm with OK.

11. Save the application with the **File/Save** menu (default name : appli1.dop)

3. Loading the application into the terminal

1. Switch on the terminal
2. Connect the PC to the terminal (**XBT Z915 cable, index 22**) then select the Transfer/Export command to transfer the application to the terminal.

B

4. PLC application

The dialogue table (%MW10 to %MW14) can be used if the authorisation word (%MW12) is equal to 'A505' in hexadecimal.

The designer can use various words from the dialogue table.

Word %MW10 contains the image of the function keys (F1 key pressed : bit %MW10,0=1).

Word %MW11 contains the number of the page to be displayed (1 or 2 in the example).

Word %MW13 controls the display of the function key LEDs (F1 key bit %MW13,0).

Setting bit %MW14,0 to 1 makes the alarm page appear blinking, press ENTER to steady the display.

After transferring the application into the terminal, connect the latter to the PLC ([see service instructions for wiring : example cable XBT-Z968 for TSX07 with UNITELWAY V2.0](#)).

5. Entry and modification of parameters

Reminder

A page is composed of texts and fields. A field may correspond to values which have to be filled in (write) or modified (read/write) by the user or to values written by the PLC.

Example :

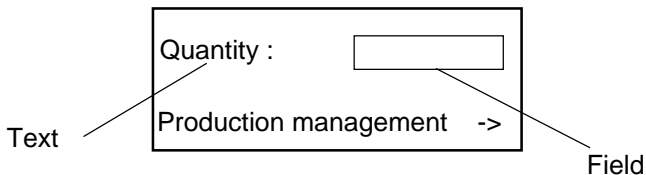

Entry principle

MOD

Entry mode is accessed using the MOD key.

- If the field contains more than 1 digit, the digit to be entered is displayed in steady mode, while other digits blink.
- If the field contains 1 digit, the digit to be entered blinks.

Entry via numeric keypad

Keys 0 to 9 and +/- (toggle function, + is the default sign) are used to enter data.

- Enter the first digit, the following digit (to the right) stops blinking.
- Enter the second digit.
- Enter the other digits and confirm the whole entry with **ENTER**

Entry using arrow keys



- Select position on the digit to be entered using the arrow keys.



- Increment or decrement the value of the digit with the arrow keys.



- Go to the next digit with the arrow keys.

- Confirm the whole entry with **ENTER**.

Deleting characters

The **DEL** key deletes the character to the left of the steady digit.

To delete the last steady digit :

- Move the cursor using the right arrow key.

- Press the DEL key



Section C

Magelis functions

This Section covers the following topics :

1. Organisation of Magelis functions	C-5
2. Starting up the terminal	C-6
3. Keys and indicator lamps	C-7
4. Operating principle	C-10
5. Page display	C-17
6. Entry and modification of variables	C-21
7. Alarms	C-25
8. Alarm page log	C-34
9. Process control via function keys	C-40
10. Locking function keys via the PLC	C-42
11. Printing	C-44
12. Configuration	C-48
13. Products references	C-51
14. Product selftest	C-52
15. Forms	C-54

1. Organisation of Magelis functions

Magelis terminals (or XBTs) offer a number of functions. The flow charts below show the links between these functions. The table at the bottom of each page shows whether your terminal has access to the function.

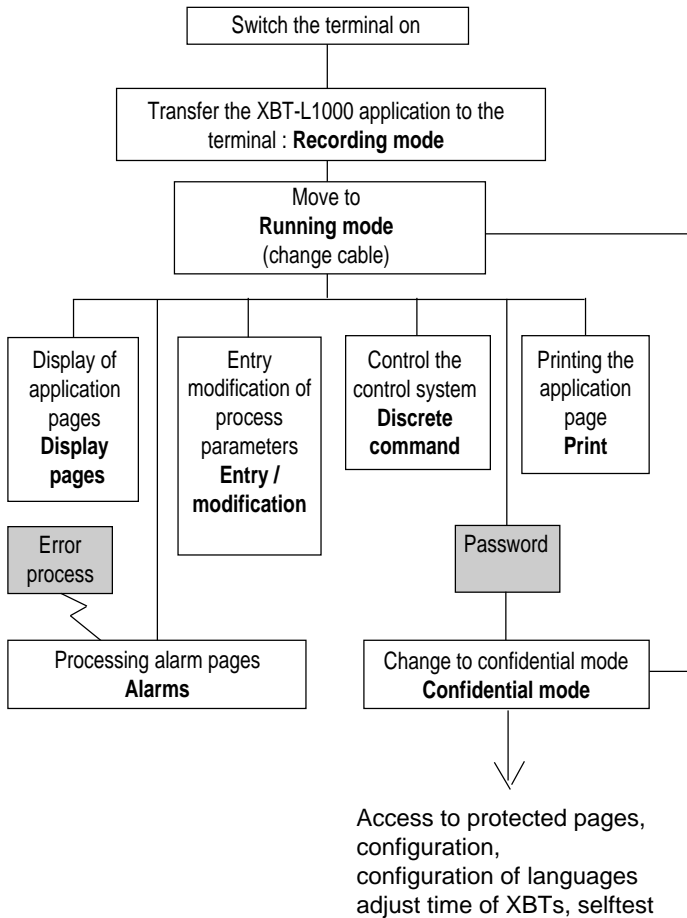









2. Starting up the Magelis terminal

[Please refer to the service instructions.](#)







Magelis	XBT-H, XBT-HM	XBT-P	XBT-E

3. Keys and indicator lamps

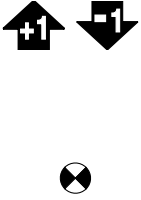



Various terminals have a number of keys and indicator lamps. Section E gives specific information about the keys and associated indicator lamps for each type of terminal. The table below summarises the functions of all the keys and indicator lamps.

Key/indicator lamp	Function key/indicator lamp
	Confirm a choice or entry, acknowledge an alarm page.
	Move to page entry, password or variable field. Move to next field each time MOD is pressed, right to left and top to bottom.
	Delete an entry or suspend or stop an action in progress. Move up one level in a menu, exit display alarm.
	Accesses the dual function on the keys.
  	<ul style="list-style-type: none"> - Change page in a menu. - Change display (concept of "turning a page" to display the list of alarms, for example). - Change digits in a variable field : INDICATOR LAMP STATUS * : <ul style="list-style-type: none"> • Off : key inactive. • On : shows that it is possible to change page in a menu (active link) or change display. • Blinking : shows that it is possible to move into the selected variable field.
 	Combined with the SHIFT key enable: - Change the display luminosity. (only Fluorescent Display).

Magelis	XBT-H, XBT-HM	XBT-P	XBT-E
	*No indicator lamp on XBT-H811050		

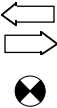
	<p>- Move around a page (activate the page links). - Select the value of a digit. - Select a value from a list.</p> <p>INDICATOR LAMP STATUS :</p> <ul style="list-style-type: none"> • Off : key inactive. • On : shows that moving around a page is possible • Blinking : shows that it is possible to modify the value of each digit.
	<p>Combined with the SHIFT key, enable:</p> <ul style="list-style-type: none"> - the value of a variable field to be incremented or decremented, in entry mode, this immediately sends the value to the controller. - access at the top or the bottom page. <p>INDICATOR LAMP STATUS :</p> <ul style="list-style-type: none"> • Off : key inactive. • On : shows that moving around a page is possible • Blinking : shows that it is possible to modify the value of each digit.
	<p>Deletes the character to the left of the steady digit.</p>
	<p>Inverts the sign of the variable field being entered.</p>
	<p>Decimal point.</p>
<p>Alphabetical keys</p> 	<p>These keys which are accessible with the  keys give access to the character to the left, the centre, and the right respectively of the alphabetical marking.</p>
<p>HOME</p>	<p>SHIFT+ ESC : Return to the point of entry into the current menu. Example : return to the first application page.</p>
	<p>Accesses a menu containing the operating functions which are not directly accessible via keys:</p> <ul style="list-style-type: none"> • selection of application pages, • "secondary" operating functions.

Magelis	XBT-H, XBT-HM	XBT-P	XBT-E
	*No indicator lamp on XBT-H811050		

<p>SYST</p> 	<p>SHIFT + MENU : Accesses confidential mode which contains the setup functions (protected by a password) :</p> <ul style="list-style-type: none"> - installation and maintenance functions, - change from running mode to confidential mode. <p>INDICATOR LAMP STATUS :</p> <ul style="list-style-type: none"> • Off : the terminal is in running mode. • On : the terminal is in confidential mode. • Blinking : PC<-> XBT transfer is in progress or no application in the terminal.
	<p>INDICATOR LAMP STATUS * :</p> <ul style="list-style-type: none"> - indicator lamp on : no cable or incorrect wiring, - indicator lamp off : correct cable, no exchange with the PLC, - indicator lamp blinking : exchanges with the PLC.
	<p>INDICATOR LAMP STATUS * :</p> <ul style="list-style-type: none"> • Off : no key pressed. • On : when any key is pressed.
<p>ALARM</p> 	<p>SHIFT+ ENTER: consult alarms</p> <p>INDICATOR LAMP STATUS :</p> <ul style="list-style-type: none"> • Off : the current alarm list is empty. • On : the list contains some alarms which have already been displayed (ignored). • Blinking : the alarm list contains some new alarms.
<p>PRINT</p> 	<p>SHIFT+ MOD: print command</p> <p>INDICATOR LAMP STATUS :</p> <ul style="list-style-type: none"> • Off : no printing in progress, • On : printing in progress. • Blinking: printing fault.

Magelis	XBT-H, XBT-HM	XBT-P	XBT-E
	*No indicator lamp on XBT-H811050		

4. Operating principle

Basic principle

1 - MAGELIS terminals have 3 operating modes :

- **Recording mode** enables XBT-L1000 ÷ MAGELIS exchanges.

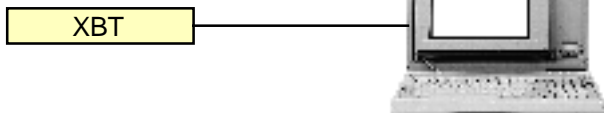

- **Running mode** enables, when connected with the process, the control system to be controlled.

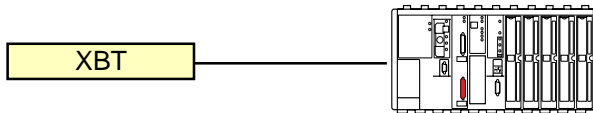

- **Confidential mode** enables, in addition to the functions of the running mode, access by password to privileged functions (log, etc).

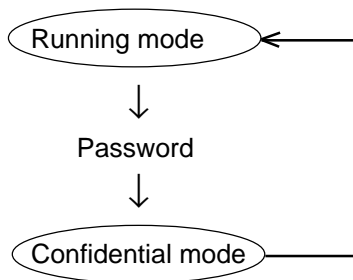

Magelis	XBT-H, XBT-HM	XBT-P	XBT-E
	No confidential mode		

- 2 - When the terminal is switched on, the operating mode is selected automatically, according to the connection of the XBT :
- if the XBT is connected to the PC with XBT-L1000 software : save mode.
 - if the XBT is connected to the control system : running mode (with the possibility of changing to confidential mode).



Magelis	XBT-H, XBT-HM	XBT-P	XBT-E

4.1. Recording mode

Exchanges between the MAGELIS terminal and XBT-L1000

2 types of exchange are possible :

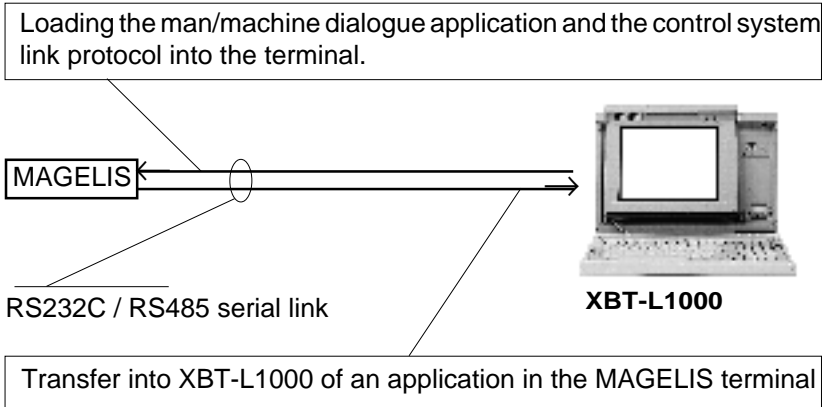

The **SYST** indicator lamp blinks during the transfer *.

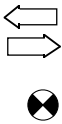

Communication indicator lamp *

- indicator lamp on : no cable or incorrect wiring,
- indicator lamp off : correct cable, no exchange with the PLC
- indicator lamp blinking : exchanges with the PLC.

Procedure with XBT-L1000

Select the Transfer/Export menu.

PC<-> Magelis terminal cables. Connection port to the PC



- 9-pin male serial port : XBT-Z915 V22.
- 25-pin female serial port : XBT-Z905 V22.
- 9-pin female serial port : XBT-Z9152 V12.

Magelis	XBT-H, XBT-HM	XBT-P	XBT-E
	*No indicator lamp on XBT-H811050		

4.2. Running mode

The running mode is used to control the control system :

- Page display.
- Entry/modification of process parameter values.
- Process control (discrete).
- Printing.
- Viewing and acknowledgement of an alarm.



If the terminal has a MENU key, you can access the following additional functions :

- display of application pages (indirectly),
- consult the alarm log,
- access to the terminal configuration (printer link, real-time clock, link with the control system, languages)
- access to the product references,
- access to the terminal selftest functions (keyboard, display...)



Example : Display of an application page



Solution 1 : once the Menu screen is displayed, press the

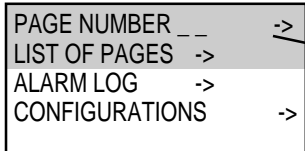

indicator lamps blink

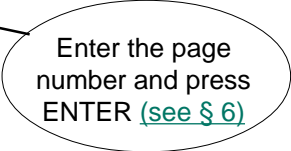

Solution 2

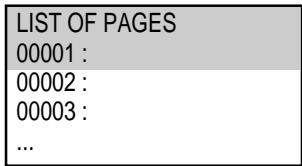

Select the required page (example page 3),
access the page.



In this mode the SYS indicator lamp is off.

Magelis	XBT-H, XBT-HM	XBT-P	XBT-E
	No function "menu"		

Configuration for operation

Operation via the terminal port RS485 type of a PLC

- Terminals concerned: XBTH / XBTP / XBTE with UNITELWAY protocol.
- PLC : TELEMECANIQUE PLC with an RS485 type terminal port interface (type TSX07, TSX17 etc.).
- Type of link : RS485 point-to-point.
- Protocol :UNITELWAY

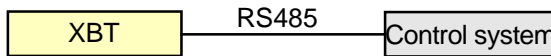

Operation with point-to-point direct link to the control system

- In this case the control system designates a system other than a PLC.
- Terminals concerned: all, except terminals using UNITELWAY protocol *.
- Type of link :
 - RS422 or RS485.
 - RS232.
- Protocol: control system function.

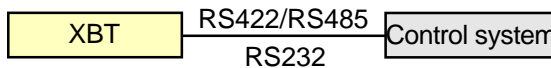

Magelis	XBT-H, XBT-HM	XBT-P	XBT-E
	* XBT-H811050: UNI-TE protocol only		

Operation on a PLC communication network

- PLC : PLC supporting the communication protocol of the terminal,
- Type of link : RS422 or RS485 (multidrop),
- Protocol : multidrop protocol (UNITELWAY, JBUS, MODBUS, etc).

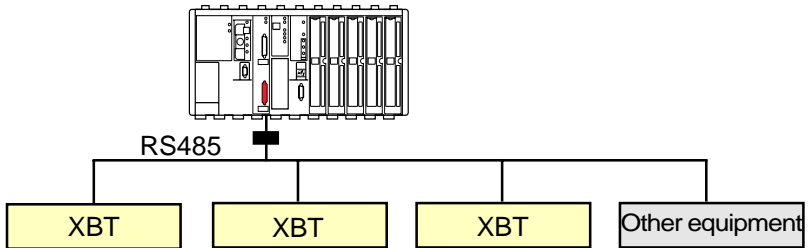

Communication indicator lamp*



- indicator lamp on : no cable or incorrect wiring,
- indicator lamp off : correct cable, no exchange with the PLC,
- indicator lamp blinking : exchanges with the PLC.

Magelis	XBT-H, XBT-HM	XBT-P	XBT-E
	*No indicator lamp on XBT-H811050		

4.3. Confidential mode

Confidential mode enables the running mode functions to be performed and, in addition, the following functions :

- Access to pages protected in running mode.
- Clearing the log.
- Configuration of the MAGELIS terminal and peripherals
- Terminal selftest

A password to protect the access to the confidential mode is created using XBT-L1000.

Changing to confidential mode



  Press the SYST key.

Enter the password using the arrow keys or the numeric keypad, and confirm the entry with ENTER. The entry principle is described [in § 6](#).
Select confidential.



The SYST indicator lamp lights.

Exiting confidential mode

  Press the SYST key.



Select running mode.



The SYST indicator lamp goes off.

Magelis	XBT-H, XBT-HM	XBT-P	XBT-E
	No confidential mode		

5. Page display

5.1 Display when powered up

When it is switched on, the terminal automatically displays the system pages (duration 2 secs) :

- Display of the reference and the software version loaded
- Display of the product reference of the terminal
- Display of the reference and the version of software downloaded by XBT-L1000.
- Display of the reference and the version of the protocol
- Display of the application name.

The terminal then continuously displays the date and time or the default page.

Design using XBT L1000:

The procedure for displaying a default page is as follows:

- Select the Configuration/Terminal Parameters menu.
- Select the default page to be displayed.

5.2 Page display via links

- A link between pages is indicated by the -> and <- arrows.

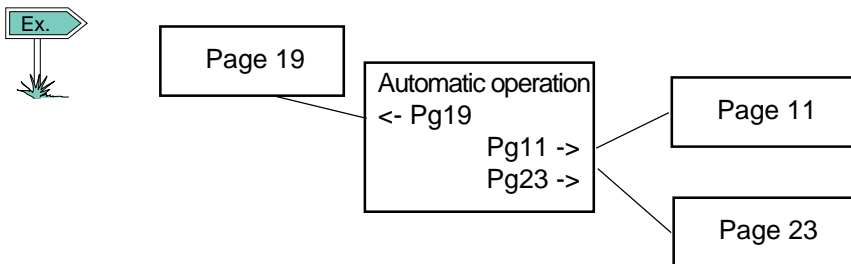

- If a page is accessible, the -> or <- arrow is displayed blinking in reverse video. Otherwise the display is steady, indicating that the page is protected and therefore accessible only in confidential mode.

Magelis	XBT-H, XBT-HM	XBT-P	XBT-E

5.3 Displaying a page via its number

MENU

1- Press the MENU key and the XBT displays the following menu :

PAGE NUMBER _____	_____	Access via page number
LIST OF PAGES ->	_____	Access via page name

MOD

2 - Press the "MOD" key.

3 - Enter the page number to be displayed ([see § 6](#))

ENTER

4 - Press "ENTER" to confirm and the page is displayed.

Only non-protected pages can be displayed in this way in running mode. Change to confidential mode to display protected pages.

5.4 Displaying a page via its name

MENU

Press the MENU key and the XBT displays the following menu :

PAGE NUMBER _____	_____	Access via page name
LIST OF PAGES ->	_____	



Display of list of pages

LIST OF PAGES	
001 PRODUCTION	➔
005 QUALITY	->
006 MAINTENANCE	->

- If in running mode, only non-protected pages are displayed.
- If in confidential mode, both protected and non-protected pages are displayed.



Select the page.



Access the page.

Magelis	XBT-H, XBT-HM	XBT-P	XBT-E
	No Menu function		

5.5 Displaying a page via a function key

It is possible to display a page directly by pressing a function key.

Example :

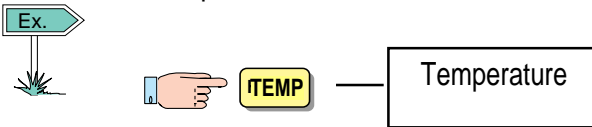

Temperature

Procedure for assigning a function key to a page with XBT-L1000

Select the Configuration / Function keys menu.

Select the group of keys, then the required function key. Confirm with OK.

Select the type of operation : direct acces.

Select the page

Confirm with OK.

Magelis	XBT-H, XBT-HM	XBT-P	XBT-E
	Except for XBT-H011010 XBT-H012010, XBT-H811050		

5.6 Page display initiated by the PLC

The dialogue table (see Section D) is used for dialogue between the PLC and the terminal. In this table a word is reserved into which the program writes the number of the page to be processed.

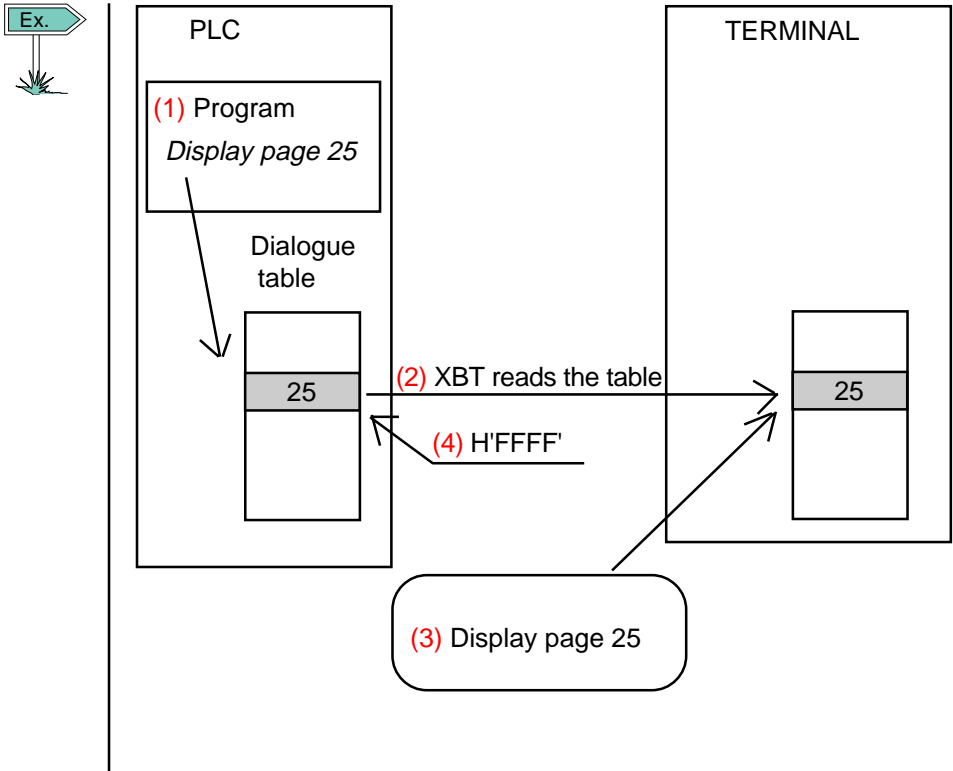

The terminal reads the dialogue table in the PLC (2) and displays the required page (3). It is not necessary to write a programme in the PLC to control the communication.

(4) Once the command is processed, the terminal writes H'FFFF' in the page word to be processed.

Magelis	XBT-H, XBT-HM	XBT-P	XBT-E

6. Entry and modification of variables

Reminder

A page consists of text and fields. A field may correspond to values which have to be filled in (write) or modified (read/write) by the user or to values written by the PLC.

Example :

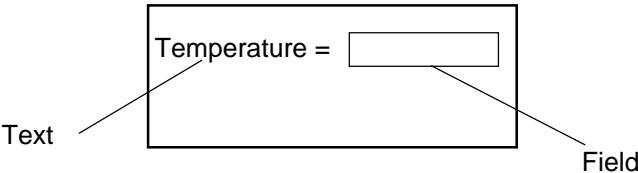

6.1 Entry request

6.1.1 By the operator



Entry mode is accessed with the MOD key.

6.1.2 By the PLC

The PLC writes the number of the field in the word "Field to enter" in the dialogue table.

6.2 Entry principle

- If the field contains more than 1 digit, the digit to be entered is displayed in steady mode, whilst the other digits blink.
- If the field contains 1 digit, the digit to enter blinks.
- The LEDs of the arrow keys blink. Note : when the LEDs are off, the corresponding keys are inactive

Entry via numeric keypad

Keys 0 to 9 and +/- (flip/flop function, + is the default sign) are used to enter data.

- Select the digit to be entered using the arrow keys.
- Enter this digit, the following digit (to the right) stops blinking.

Magelis	XBT-H, XBT-HM	XBT-P	XBT-E
Except XBT-H001010, 002010, 021010, 022010 and XBT-HM 007010, 027010			

- Enter the next digit.
- Enter the other digits and confirm the whole entry with **ENTER**.
- Entering the first digit of a field without having used the  keys causes the rest of the field to be deleted.

Entry via the arrow keys



- Select the digit to be entered using the arrow keys.



- Choose the value of the digit using the arrow keys.



- Move to the following digit using the arrow keys.
- Confirm the whole entry with **ENTER**.

Incrementing/decrementing a value

If you want to adjust a value
(example : adjust around the value 5556)

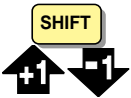

- Press the SHIFT + up arrow keys to increment the value by 1 point.
- Press the SHIFT + down arrow keys to decrement the value by 1 point.
- Confirm the whole entry with **ENTER**.

Deleting characters

When an immediate write access or immediate read/write access type is concerned. On each step, the value is sent to the controller. The **DEL** key deletes the character to the left of the steady digit. To delete the last steady digit :

- Move the cursor using the right arrow key until all the digits blink.
- Press the DEL key

Magelis	XBT-H, XBT-HM	XBT-P	XBT-E

Entry rule

MOD

This key is used to move between the various fields of a displayed window and to select the required field.

ESC

This key abandons the current entry ; no modification is made.

Rule regarding display of variables

A value which cannot be displayed is represented by # characters (overflow value, unknown value in a list).

A variable which is outside the limits but can be displayed flashes (alphanumeric field, bar graph or meter).

A value which is not filled in by the PLC is represented by ? characters (alphanumeric field, bar graph or meter).

A write-only variable is represented by * characters (example : password).

If the numbered list has no text, the XBT displays #'s throughout the field.

Type of data : bits, single words, double words, floating point words, character strings.

Display format : binary, integer, decimal (maximum of 5 decimal places), hexadecimal, ASCII

Limits : if the entry limits of a value have been defined with XBT-L1000 software, any entry outside these limits produces a warning message and a return to entry mode.

Access type : Read, Read/Write, Immediate Write, Immediate Read/Write.

Magelis	XBT-H, XBT-HM	XBT-P	XBT-E
Except XBT-H001010, 002010, 021010, 022010 and XBT-HM 007010, 027010			

Numbered list : XBT-L1000 software enables a text to be assigned to each value of the variable associated with the field.

- Programming with XBT-L1000 : Access the window defining the characteristics of the field, select Format/Type, click on List and assign a text to each value.

- Operation with the terminal : use the arrow keys.



Magelis	XBT-H, XBT-HM	XBT-P	XBT-E

7. Alarms

7.1. Structure of alarm pages

An alarm page has the same characteristics as an application page for :

- the text,
- the field (read only),

The additional feature of an alarm page is its event-triggered display. A word bit from the dialogue table is assigned to each alarm page. If the bit is at state 1, the page is processed.



If a sensor fault occurs, the bit associated with the sensor fault changes to 1.

Sensor fault

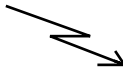

Attention Pressure sensor fault
Change to manual

Advantages in running mode

- When a fault appears, it is often as a result of other faults. The **priority system** of MAGELIS products, enables the most important fault to be displayed. In other words, the one which is most hazardous for the process.
- The occurrence of each fault is **time-stamped**.

Magelis	XBT-H, XBT-HM	XBT-P	XBT-E

Maintenance advantages

- MAGELIS terminals store the appearance of faults sequentially (log), thereby enabling an investigation into the origin of the fault.

- Several alarms may therefore appear simultaneously in the process.

These are recorded by the XBT in a special memory called the "alarm list".

The actual display of an alarm depends on the priority which it has been allocated according to the principle described in §7.3.

Alarms appearing in the process are stored in the "Alarm list".



- The "Alarm" indicator lamp continuously informs the operator about the state of the alarm list * :

- Off: the alarm list is empty.

- Blinking: the alarm list contains alarms which have appeared since the alarm list was last viewed.

- On: the alarm list contains alarms which occurred before the alarm list was last viewed.

Design using the XBT L1000

The XBT-L1000 software is used to enter the parameters of the following 3 functions for each alarm page :

- Display : the page will be displayed.

- Printing : the page will be printed.

- Storage : the page will be stored.

Magelis	XBT-H, XBT-HM	XBT-P	XBT-E
	*No indicator lamp on XBT-H811050		

7.2. Alarm page parameters

Alarm pages comprise :

- text, the object of which is to indicate :
 - the fault,
 - actions to correct the fault.



Conveyor faults
Turn power off
Remove the part
Restart conveyor



- variable fields,
- a priority,
- request for acknowledgement,
- an alarm relay command (XBT-E).

Design with XBT- L1000

Select the Page menu or the icon  New/Alarms and the window "Create alarm page" is displayed.

Assign a bit to the alarm page.

It is possible to change the name.

Confirm with OK.

Open the alarm page.

Assign the priority OK.

Enter the alarm page text.

Enter the parameters of the acknowledgement OK.

Enter the parameters of the alarm relay OK.

Magelis	XBT-H, XBT-HM	XBT-P	XBT-E

7.3. Display priority

With XBT-L1000 a priority can be assigned to each alarm page. An alarm generally has a higher priority than the display of operating pages. It is lower than the display of an entry which is in progress.

Different alarm pages can have different priorities. 16 levels of priority are possible (the lowest display priority being priority N° 16).

Special case of priority 0

If priority 0 is assigned to an alarm page, when the alarm appears on the process,

- the alarm page will not be displayed but will be stored in the alarm lists to avoid disturbing the current display.
- the alarm indicator lamp will blink to indicate the alarm.

When an alarm is activated, it is stored by the XBT in the alarm list.

Storage principle :

If of equal priority, alarms are stored in a such a way that

- the oldest is displayed first
- the others are stored one after another in their order of appearance (FIFO stack).

- If the display is available (in other words not occupied by a higher priority display), the first alarm which occurs is displayed.

If higher priority alarms appear,

- They are stored at the top of the list.
- If the display is available (in other words not occupied by a higher priority display), the highest priority new alarm is displayed.

Magelis	XBT-H, XBT-HM	XBT-P	XBT-E

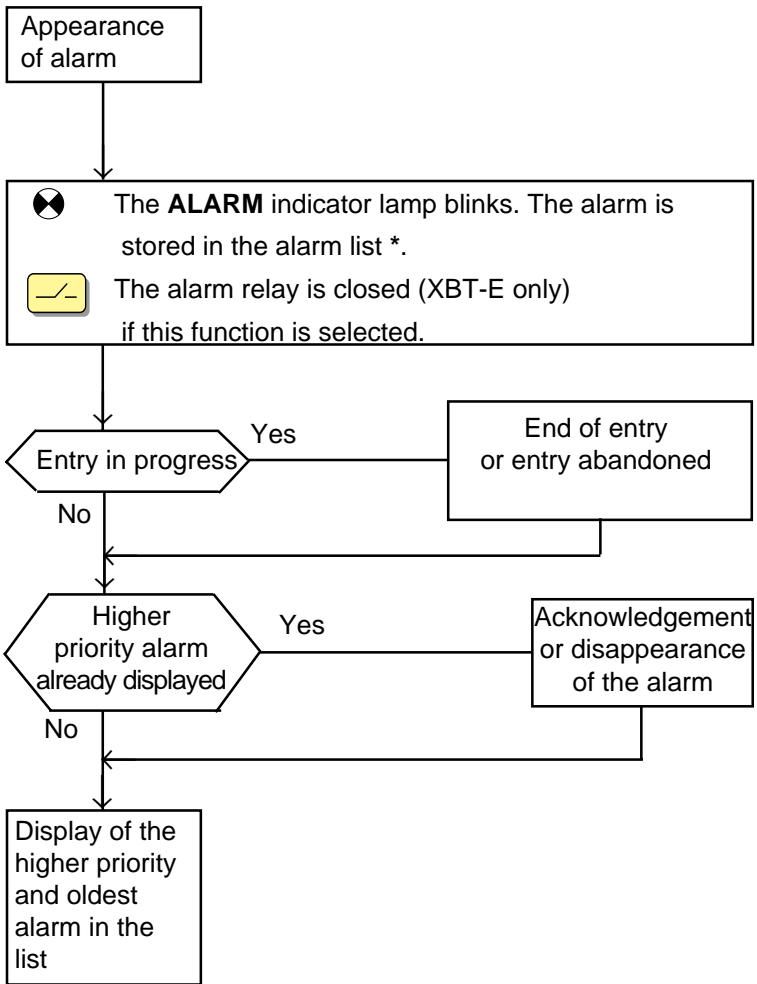

Magelis	XBT-H, XBT-HM	XBT-P	XBT-E
	*No indicator lamp on XBT-H811050		

7.4. Acknowledgement of alarms

When pages are designed, it is possible to define whether the alarm page should be systematically acknowledged or not. The management of these two types of alarm is as follows :

1 - Alarms which must be acknowledged

An alarm which must be accepted remains in the list of alarms until it is accepted, even if the cause of the fault has disappeared.

Advantage : Picks up transient faults (instability of a discrete sensor for example)

2 - Alarms which can optionally be accepted

An alarm which is optionally accepted disappears from the list of alarms as soon as the cause of the fault has disappeared, whether the alarm has been accepted or not.

Advantage : Does not monopolize the display unit with the display of faults considered of minor importance to the application.

Acceptance of alarms



Alarms are accepted on the terminal with the ENTER key. The alarm message changes to fixed display.

Design using XBT-L1000

Once the alarm page is displayed, select the Page/Acknowledgment menu ACK.

Magelis	XBT-H, XBT-HM	XBT-P	XBT-E
	Except for XBT-H021010, XBT-H022010 and XBT-HM0027010		

7.5. Control of alarm relay : XBT-E

The alarm relay is closed as soon as an alarm, defined with the "alarm relay" option, is active.

The relay is open as soon as all active alarms, defined with the "alarm relay" option, have been accepted by the operator or have disappeared.

Design using XBT-L1000

Once the alarm page is displayed, select the Page/Alarm relay menu or the icon 

C

Magelis	XBT-H, XBT-HM	XBT-P	XBT-E
	Except XBT-H and XBT-HM	Except XBT-P	

7.6. Alarm display

The dialogue table ([see section D](#)) is used for dialogue between the PLC and the terminal. In this table, words are reserved for alarm display.

The display is controlled by the PLC by setting a word bit to 1.

The XBT-L1000 software is used to assign a word bit to each alarm page.

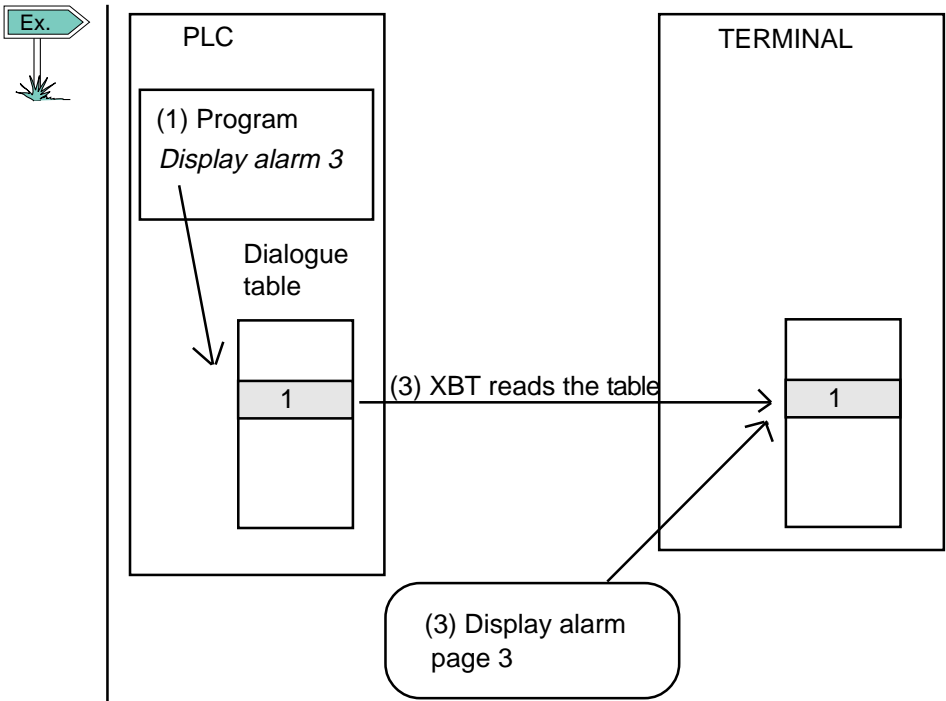

The terminal reads the dialogue table in the PLC (2) and displays the required page (3). It is not necessary to write a program in the PLC to control the communication.

Magelis	XBT-H, XBT-HM	XBT-P	XBT-E

When an alarm is displayed, the XBT reserves the first line of the display unit to display :

- the date and time of appearance and acceptance of the alarm,
- the position of the alarm in the alarm list,
- the total number of alarms in the list.

The alarm is displayed in blinking mode.



```
A 31/01 17:35 1/7
CONVEYOR FAULT
Turn power off.
Remove jammed part.
Restart.
```

Line time-stamped by the XBT ("A" for Alarm) the alarm text, in blinking mode, becomes steady once the alarm is accepted.

ESC

Ability to ignore alarms

If an alarm is displayed during operation (for example during debugging), the ESC key can be used to return to running mode, the alarm still remains in the list and the ALARM indicator lamp becomes steady.

SHIFT + ENTER

Viewing alarms

If there are alarms in the stack, the ALARM indicator lamp lights up. To access the alarm list, press the SHIFT+ENTER key : the highest priority alarm is displayed.

ESC

Exit viewing of the alarm pages.

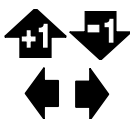

Scrolling the alarm page.

Move in the list of alarm pages.

ENTER

Acceptance.



```
A 31/01 17:35 1/7
CONVEYOR FAULT
Turn power off.
Remove jammed part.
Restart.
```



```
A 31/01 17:35 2/7
CONVEYOR DEF1
Change to N°2
```



```
A 31/01 17:35 3/7
MOTOR FAULT
Cut power supply
N°5
```

Magelis	XBT-H, XBT-HM	XBT-P	XBT-E
	XBT-H021010/022010/H00x/ H12x neither ESC, nor view.		

8. Alarm log

8.1. Principles

The XBT may control a log of alarm pages. They record the alarm pages with the text but without the variable values. The alarms are stored one after another. Once the log is full, the more recent alarms overwrite the older ones.

Each event:

- appearance,
- acceptance,
- disappearance,

of an alarm is thus recorded and time-stamped.

The following functions may be performed :

- Initiated by the PLC:

- print log,
- clear log ;

- Initiated by the operator:

- display log,
- print log ;

- At the initiative of the operator in confidential mode:

- clear log.

Design using the XBT-L1000

For each alarm page, the XBT-L1000 software sets these 3 functions:

- Display: the page will be displayed
- Printing: the page will be printed
- Storing: the page will be stored.

The Alarm page is stored only if the "MEM" option has been selected in the log.

Magelis	XBT-H, XBT-HM	XBT-P	XBT-E
	only XBT-H012110 and XBT-HM017110	only XBT-P021110 and XBT-P022110	only XBT-E01x110

8.2. Log display

MENU

Press "MENU".

Select "ALARM LOG" option in the menu then choose type of display : sequential or statistical.



Change from one alarm to another in the log.



Scrolling to display complete information on an alarm in the log.

C

Display

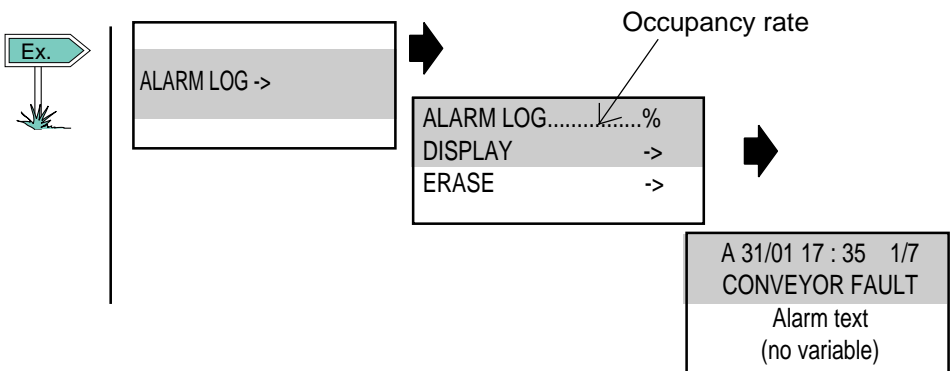

Magelis	XBT-H, XBT-HM	XBT-P	XBT-E
	only XBT-H012110 and XBT-HM017110	only XBT-P021110 and XBT-P022110	only XBT-E01x110

Display principles:

Events for each alarm if any (appearance, acknowledgement, disappearance) are displayed sequentially, gathered according to the status, with the first alarm shown at the first position.

Example:

The log contains 4 events 3 of which are related to the same alarm.

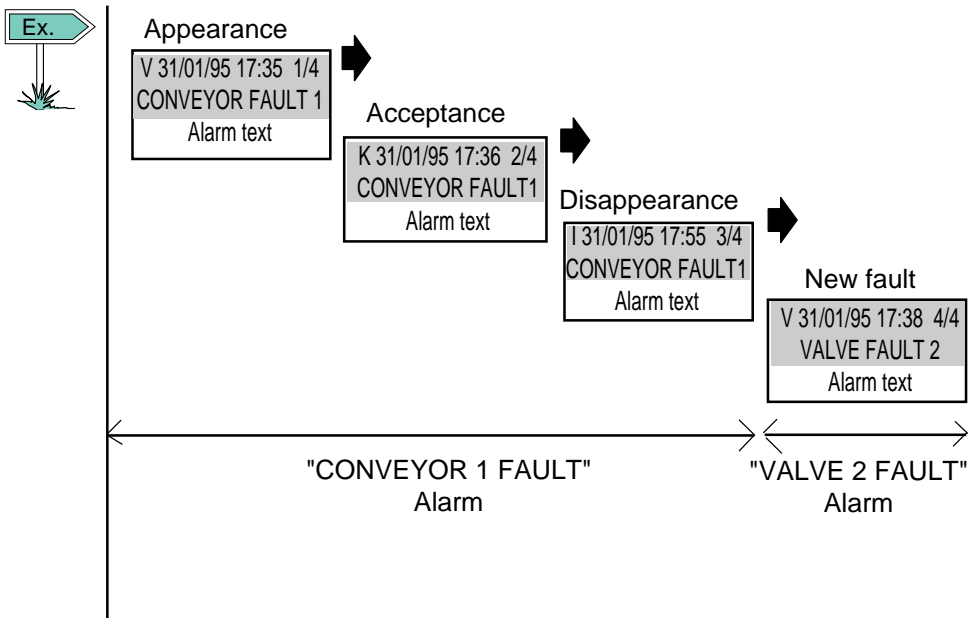

Magelis	XBT-H, XBT-HM	XBT-P	XBT-E
	only XBT-H012110 and XBT-HM017110	only XBT-P021110 and XBT-P022110	only XBT-E01x110

8.3. Clear log

•Clearing initiated by the operator (in Confidential mode)

MENU Press MENU key.

Choose the "ALARM LOG" menu.
Choose "Clear log" (only in Confidential Mode).

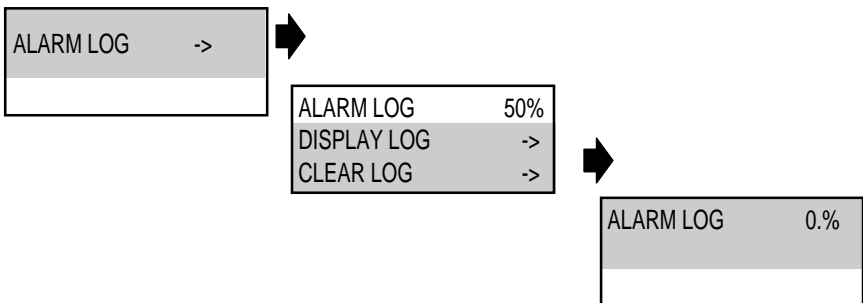

•Clearing initiated by the PLC

The log is cleared using the command word in the dialogue table to reset the log ([see chapter D](#)).

Magelis	XBT-H, XBT-HM	XBT-P	XBT-E
	only XBT-H012110 and XBT-HM017110	only XBT-P021110 and XBT-P022110	only XBT-E01x110

8.4. Print log

SHIFT + **MOD**

•Printing initiated by the operator

Press the PRINT key and select the "Alarm log" option.

The following is displayed:



PRINTING	
HARD COPY	->
ALARM LOG	->
FORMS	->
STOP PRINTING	->

•Selecting "Alarm log" option:

The log is printed in sequential mode, the most recent alarm is displayed first.

For each alarm, the following items will be printed on the same line:

- the page name,
- date and time of appearance
- date and time of acceptance,
- date and time of disappearance.

•Printing initiated by the PLC:

The log is printed using the print word command in the dialogue table [\(see chapter D\)](#).

The log is printed in sequential mode (by status), the most recent alarm will be printed first.

For each alarm, these items are printed first and on the same line: name, date of time of appearance (Valid), acceptance (ACK), disappearance (Invalid).

Magelis	XBT-H, XBT-HM	XBT-P	XBT-E
	only XBT-H012110 and XBT-HM017110	only XBT-P021110 and XBT-P022110	only XBT-E01x110

Its text cannot be printed in a compact format. The recommended print format is 80 character width. The printed header shows the date and time of the alarm log printing.



Example:

ALARM LOG	Valid	Ack	Invalid.
05/09/95 11:26			
00013: VAT 3 HOT	05/09/95 10:10:05		
00011: VAT 1 HOT	05/09/95 09:15:02		
00012: VAT 2 HOT	05/09/95 08:58:48	05/09/95 09:02:03	
00013: VAT 3 HOT	05/09/95 08:10:05	05/09/95 08:11:02	05/09/95 08:16:75

Alarm 11 is present but not acknowledged

Alarm 12 is present and acknowledged

Alarm 13 appeared (twice), was acknowledged and disappeared (once).

Magelis	XBT-H, XBT-HM	XBT-P	XBT-E
	only XBT-H012110 and XBT-HM017110	only XBT-P021110 and XBT-P022110	only XBT-E01x110

9. Process control via function keys

MAGELIS terminals can control the control system via the function keys. Two types of control are possible :

Momentary contact command

By pressing a function key, the system is activated. The action stops when the key is released.



Motor command

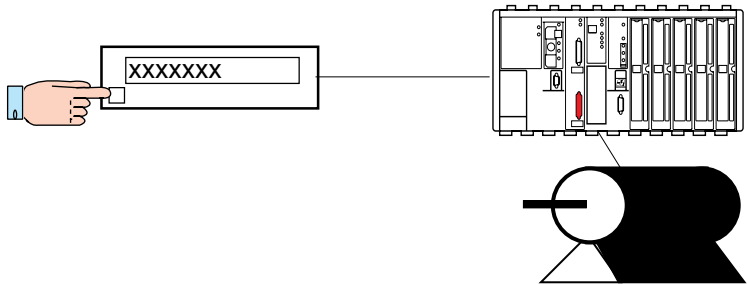

Push on/push off toggle command

The control system is activated by pressing a function key. The action is halted by pressing the function key again.



Forward command for a conveyor

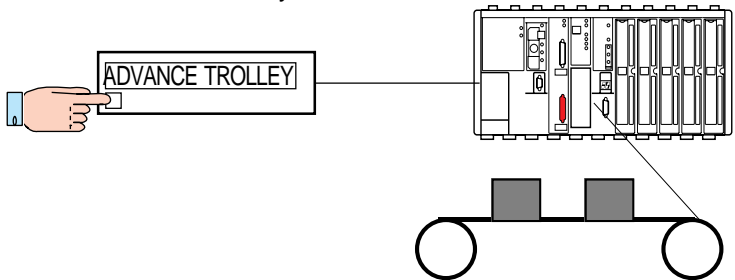

XBT-L1000 software can be used to assign a bit to each function key, as well as to determine the type of control.

Magelis	XBT-H, XBT-HM	XBT-P	XBT-E
	Except XBT-H00xxxx, XBT-H01xxxx, XBT-H811050 XBT-HM 007010 and 017xxx		

Assigning function keys using XBT-L1000

The dialogue table ([see section D](#)) is used for dialogue between the PLC and the terminal. In this table, words are reserved for the indication of the state of the function keys in the form of a word bit : bit at 1 = key pressed

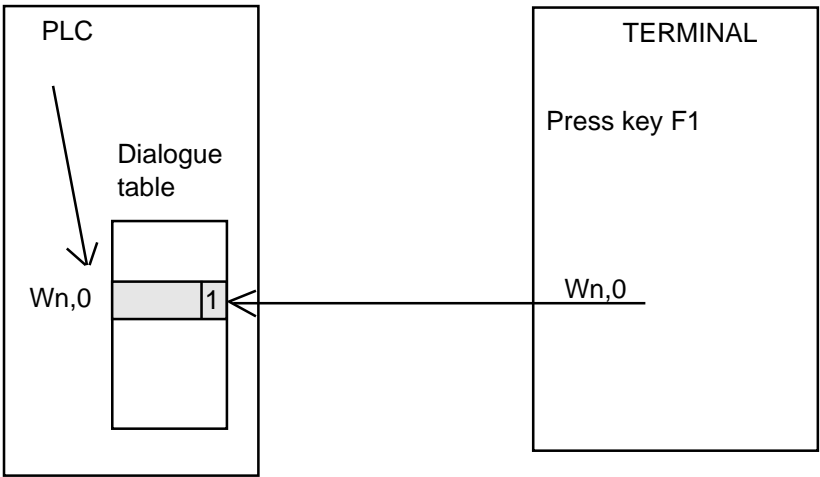
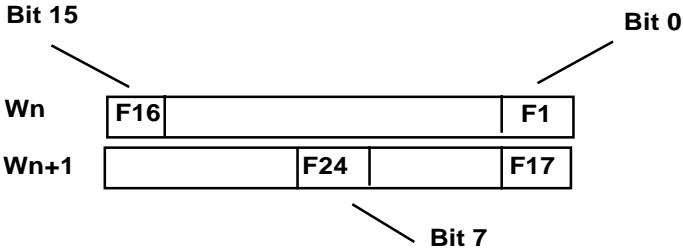

The terminal writes to the PLC dialogue table. It is not necessary to write a program in the PLC to control the communication.

Magelis	XBT-H, XBT-HM	XBT-P	XBT-E
	Except XBT-H00xxxx, XBT-H01xxxx, XBT-H811050 XBT-HM 007010 and 017xxx		

10. Locking function keys via the PLC

Each of the terminal's keys may be locked by the PLC. The dialogue table ([see section D](#)) is used for dialogue between the PLC and the terminal. In this table, words are reserved for locking the various function keys in the form of a word bit : bit at 1 = key locked.

Function keys

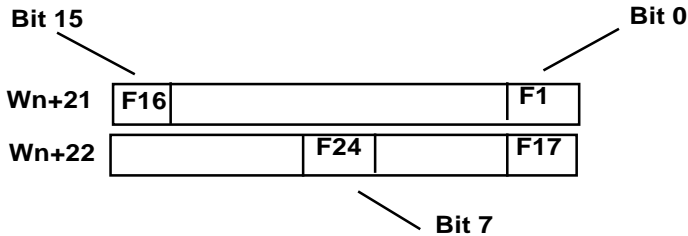

Other keys:

Wn+23

- Bit 0: Up arrow
- Bit 1: Down arrow
- Bit 2: Right arrow
- Bit 3: Left arrow
- Bit 4: MOD
- Bit 5: PRINT
- Bit 6: MENU
- Bit 7: SYST
- Bit 8: ALARM
- Bit 9: EXIT
- Bit 10: HOME
- Bit 11: +1
- Bit 12: -1
- Bit 13: ENTER

Wn+24

- Bit 0: 0
- Bit 1: 1
- Bit 2: 2
- Bit 3: 3
- Bit 4: 4
- Bit 5: 5
- Bit 6: 6
- Bit 7: 7
- Bit 8: 8
- Bit 9: 9
- Bit 10: .
- Bit 11: +/-
- Bit 12: DEL

Magelis	XBT-H, XBT-HM	XBT-P	XBT-E

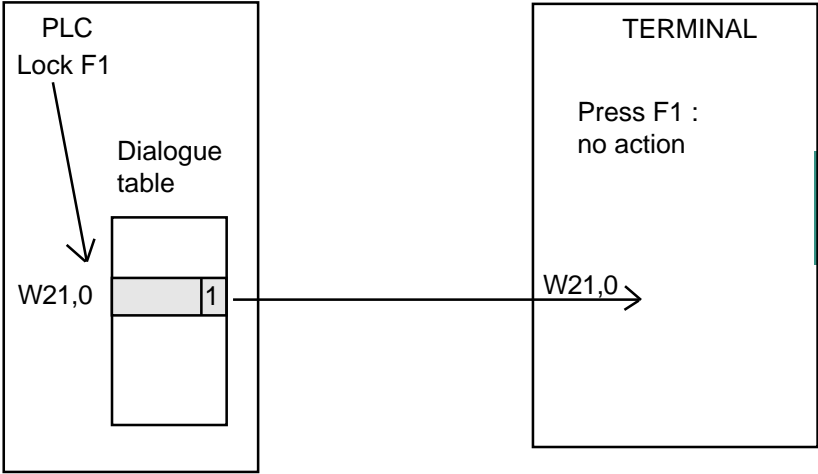

The terminal reads the PLC dialogue table and locks those keys whose word bit is at 1. It is not necessary to write a program in the PLC to control the communication.

Magelis	XBT-H, XBT-HM	XBT-P	XBT-E

11. Printing

11.1 General

The printing of the following information may be

Initiated by the operator:

- Hard copy of the displayed page,
- Alarm log,
- Forms,
- Stop printing,



+



In all cases the command is executed using the PRINT key.

Initiated by the PLC :

- Alarm log,
- Free format printing,
- Forms,
- Printing "Application page".

General principles (initiated by the operator):

The print process is executed by the PRINT key. Formatting is performed according to the printing configuration selected using XBT-L1000.

After pressing the PRINT key, the following is displayed:



PRINTING	
HARD COPY	->
ALARM LOG	->
FORMS	->
STOP PRINTING	->

Selection of one of the options.

Magelis	XBT-H, XBT-HM	XBT-P	XBT-E
	only XBT-H012110 and XBT-HM 017110	only XBT-P021110 and XBT-P022110	only XBT-E01x110

After selecting one of the options:

- If printing is enabled, transient display of :

PRINTING
ACKNOWLEDGED

- If printing is in progress, transient display of:

ACTION DISABLED
PRINTING IN PROGRESS

- If the printer is faulty, transient display of:

PRINTER FAULT

- If the fault disappears and a printing was on progress at the time the fault occurred, printing resumes where it stopped (unless a STOP PRINTING command has been executed).

Note:

If the printer has been configured with a number of characters less than the requested print format, the printout will be truncated. Characters >125 and <32 are replaced by '.' on the printout. Except for free format and form printing.

11.2 STOP PRINTING

This function is accessible by pressing the "PRINT" key. Any printing in progress (Log, continuous...) even though the printer is faulty, will stop without request for confirmation; i.e. the print buffer is cleared as well as any waiting command.

Magelis	XBT-H, XBT-HM	XBT-P	XBT-E
	only XBT-H012110 and XBT-HM 017110	only XBT-P021110 and XBT-P022110	only XBT-E01x110

11.3 Continuous printing of an alarm page

This option must be chosen at the time the page was created using the XBT-L1000:

The Alarm page must show "IMP" selected.

This function is initiated via the dialogue table when the alarm occurs.

At each read cycle of the dialogue table, "printable" alarms ("IMP" selected on XBT-L1000), are printed with the page text (25 lines at maximum) and the values for variables.

The printed header shows: the page number, name, date and time of the printing.



```

PRINT
05/09/05    10:26
00015: STOP MOTOR

(Page text)
    
```

Note:

Up to 16 "printable" alarms that appear simultaneously are printed.

Magelis	XBT-H, XBT-HM	XBT-P	XBT-E
	only XBT-H012110	only XBT-P021110 and XBT-P022110	only XBT-E01x110

11.4 Display Hard Copy

This function is accessible by pressing the "PRINT" key. If the printer is busy, the display will be refused and a transient message will appear.

The whole page is printed (up to 25 lines) with the variables.

The printed header shows: the page number, name, date and time of the printing.



```

HARD COPY
05/09/05  10:30
00425: STOP MOTOR 2

(Page text with variables)
    
```



11.5 Log printing

[See chapter 8 "Log Alarm"](#)

11.6 Form printing

[See chapter 15 "Forms"](#).

11.7 Free format printing

Only initiated by the operator;



Accessible via the dialogue table using the print command word and via the free format printing table ([see section D](#)).

Magelis	XBT-H, XBT-HM	XBT-P	XBT-E
	only XBT-H012110 and XBT-HM 017110	only XBT-P021110 and XBT-P022110	only XBT-E01x110

12. Configuration

This function, only available in confidential mode, enables the following parameters to be viewed.

- the system language,
- the application language,
- the parameters of the PLC <-> XBT line,
- the terminal date and time,
- the parameters of the Printer <-> XBT line.

 +  Switching to the confidential mode

 Press the "MENU" key to display the menu.
Position the cursor on "CONFIGURATION".



PAGE NUMBER _ _	->
PAGE LIST	->
ALARM LOG	->
CONFIGURATIONS	->
PRODUCT REFERENCES->	
SELFTEST	->



Access configuration. The configuration menu is displayed.

SYSTEM LANGUAGE	->
APPLICATION LANGUAGE->	
LINE PARAMETERS	->
PRINTER PARAMETERS	->
DATE/TIME	->

System language

The language is that in which information messages and terminal menus are expressed. The operator can find out and modify the system language. Position the cursor on the corresponding line using the up and down arrow keys and then access the content using the right arrow key. To change the language press MOD, choose the language using the up and down arrow keys and confirm with ENTER

Magelis	XBT-H, XBT-HM	XBT-P	XBT-E
	Except XBT-H and XBT-HM		

Application language

In the XBT-L1000 software, application can be entered in 3 different languages. To find out application language, position the cursor on the corresponding line using the up and down arrow keys and access the content using the right arrow key to change the language, press MOD, select the language using the up and down arrow keys and confirm pressing ENTER.

Parameters of the PLC <-> XBT line

To ascertain the parameters of the PLC <-> XBT line, position the cursor on the corresponding line using the up and down arrow keys whilst in confidential mode and then access the content using the right arrow key. According to the protocol, some parameters may or may not be modified.

The parameters displayed depend on the protocol :



UNI-TE protocol:

- Speed in bauds,
- Parity,
- Slave number,
- Error counter n°1,
- Error counter n°2,
- Error counter n°3,
- Error counter n°4,
- Reset the counters (Y/N)

To RESET the counters, Press **MOD**

Use up and down arrow keys to indicate choice yes (Y) or no (N) to erase counter and confirm with ENTER

Terminal date and time

To know and modify the terminal date and time, position the cursor on the corresponding line using the up and down arrow keys whilst in confidential mode and then access the content with the right arrow key.

Entry is the same as for the modification of parameters ([see §6](#)). The separators / and : may be replaced by full stops.

Magelis	XBT-H, XBT-HM	XBT-P	XBT-E
	Except XBT-H and XBT-HM		

Access to terminal internal timer:

The DATE and TIME (DD/MM and HH:MM) can be displayed in an application page using XBT internal words.

Example: DATE: DD/MM/YY TIME: HH:MM:SS

Field No. 1 (DD/MM) defines as follows:

Associated variable:	Wi with i = 50000
Equipment:	XBT
Format:	String
Type:	ASCII
Length:	5 (8 max. for full display)
Access:	Read only

Field No. 2 (HH:MM) defines as follows:

Associated variable:	Wi with i = 50001
Equipment:	XBT
Format:	String
Type:	ASCII
Length:	5 (8 max. for full display)
Access:	Read only

It is advisable to select a read only access or to use the CONFIDENTIAL mode to change the date and time.

When the timer variables are to be changed, you must use a separator such as "." or the right arrow to insert a SPACE between DD and MM or HH and MM.

When you change internal words 50000 and 50001, you also change the contents of two words out of the four "Terminal Date and Time words for the controller" (if they have been selected in the dialogue table).

Magelis	XBT-H, XBT-HM	XBT-P	XBT-E

When you change one of the four "Time Setting" words (if they have been selected in the dialogue table), you also change the contents of internal words 50000 and 50001.

Parameters of the printer <-> XBT line

Parameters displayed by default:



PRINTER PARAMETERS: ->	
SPEED:	9600 BDS
PARITY:	ODD
FORMAT:	8 BITS
BITSTOP:	1 BIT
LINK:	RS 232
DUPLEX:	FULL
CHARACTERS	80
FORM FEED:	NO
AUTO LF:	CR LF



Adjusting the parameters:

- position the cursor on the corresponding line using the up and down array keys, then access the content using the right arrow key.

Magelis	XBT-H, XBT-HM	XBT-P	XBT-E

13. Product references

- Push on **MENU** key to display the "menu"
- Select "PRODUCT REFERENCES"

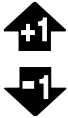

PAGE NUMBER _ _	->
LIST OF PAGES	->
ALARM LOG	->
CONFIGURATIONS	->
PRODUCT REFERENCES	->
SELFTEST	->



Accessing the Product Reference menu:

Displayed data:

- Name of the downloaded application, date and time of creation of the application.
- Software reference and release.
- Commercial reference of the product.
- Name of the downloaded exe. file.

Magelis	XBT-H, XBT-HM	XBT-P	XBT-E

14. Product selftest

Permanent selftest:

Selftest is permanently performed on the programme and application memories.

If a malfunction is detected which prevents the product operation, the terminal switches all its indicator lamps and stops running.

Manual selftest*:

- In "Confidential mode" ([see § 4.3](#)), the user may request, via the "system menu" the manual test of the terminal parts not covered by the permanent test.

Available functions:

- Display test,
- Keyboard test,
- Buzzer test (XBT-E),
- Relay test (XBT-E),
- Serial link test.

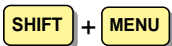

Change to confidential mode
Press the "Menu" key to display the menu.



Position the cursor on "Selftests".

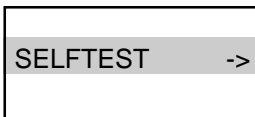

Accessing the selftests, the menu is displayed

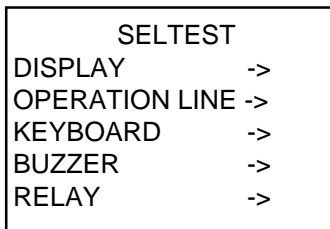

Magelis	XBT-H, XBT-HM	XBT-P	XBT-E
	Except XBT-H and XBT-HM		

Display test:

Test process,

- the display switches off,
- a horizontal line of pixels scrolls up down,
- a vertical line of pixels scrolls from left to right.

To stop the test, press the  key.

Serial link tests:

Carefully plug in the test connector on the link to be tested before initiating the test.

Test connectors:

- **Operation link type RS 232, connect pins 2-3.**
- **Operation line type RS 422, connect pins 4-6 and 5-18.**
- **Printer link type RS 232, connect pins 2-3.**

Then, test the link with the test connectors by pressing the  key.

If the displayed result is "OK", the link is correct. 

Remove the test connector and start the test (pressing the key).

The result must be "NOK".

The link is correct if both tests have had the results shown above.

Magelis	XBT-H, XBT-HM	XBT-P	XBT-E
	Except XBT-H and XBT-HM		

15. Forms

15.1 Purposes

The user may want to print measurement reports, production monitoring, product labels, etc...Forms that are printed feature various widths and lengths.

The example below shows a label whose size, reference, warranty date are variables of the PLC programme read by the terminal before printing.

Creation using XBT-L1000

```
EEPROM BOARD [99] KBYTES
REF. [AAAAAAAAAAAA]
WARRANTY: [99-99]
```

Result on printer

```
EEPROM BOARD [56] KBYTES
REF. XBT-Z800056
WARRANTY: [09-96]
```

15.2 Definition

- The quantity of forms is limited to 255 (N°1 to N°255).
- One form contains up to 132 characters X 60 lines.
- Forms are created using the XBT-L1000 as application pages or as alarms.

The form takes all from the pages, i.e., as a reminder:

- name of the form on 12 characters,
- number of the form,
- number of variable fields limited to running pages,
- multilanguage,
- protection by a password.
- The forms cannot be viewed from the terminal but only from the printer (because of format differences between the display with 20 characters and the printer with up to 80 characters).

Magelis	XBT-H, XBT-HM	XBT-P	XBT-E
	only XBT-H012110	only XBT-P021110 and XBT-P022110	only XBT-E01x110

15.3 Utilization

Initiated by the PLC: [\(see chapter D\)](#)

Initiated by the operator:

This function is accessible:

- in running mode via function key,
- pressing the "PRINT" key via the selection of the "FORMS" sub-menu. Then, select the form as you'll do for the list of pages, by the name in the form list or by the number that you enter.

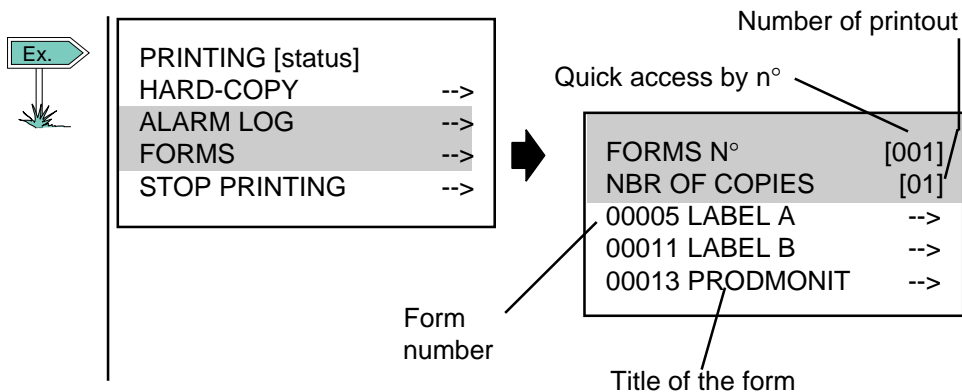

The operator chooses the form by scrolling the pages and using the arrow key . Variables are read in the PLC then the printing is done.

Real-time setting is possible via the PLC internal variables: date and time. Moreover, the user can specify the number of printouts via the "NBR OF COPIES" field which has been previously selected at 1.

Magelis	XBT-H, XBT-HM	XBT-P	XBT-E
	only XBT-H012110	only XBT-P021110 and XBT-P022110	only XBT-E01x110

Section D

**PLC/Magelis terminal
dialogue**

This section covers the following topics :

1. Introduction	D-5
2. Data exchanged	D-5
3. Principle of exchanging data associated with fields	D-7
4. Principle of the dialogue table	D-8
5. Contents of the dialogue table	D-9

D

1. Introduction

Man/machine dialogue between the Magelis terminal and the PLC consists of an exchange of data between the 2 devices.

In every communication problem, it is advisable to define :

- the data to be exchanged
- the protocol
- etc.

2. Data exchanged

Various types of data may be exchanged

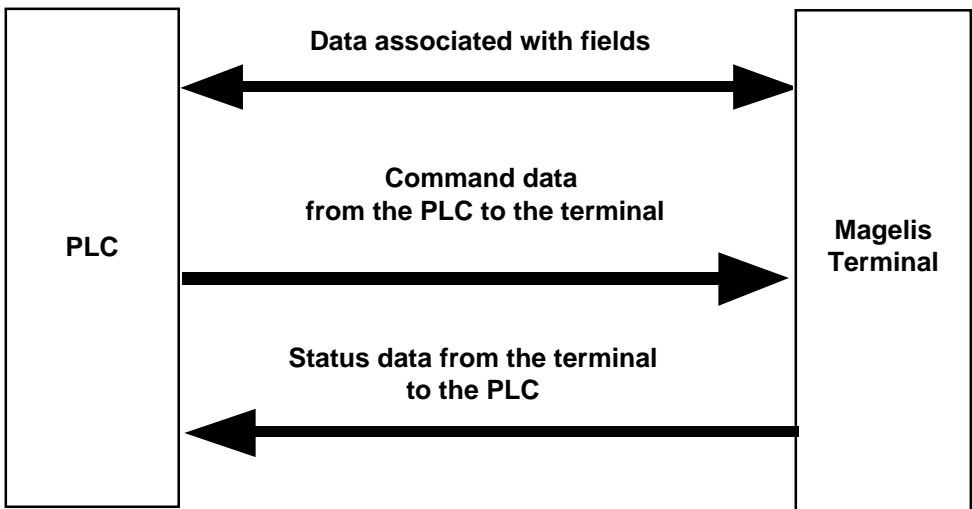

D

Data associated with fields

These are variables which may be :

- displayed on the terminal,
- entered or modified via the terminal.

Command data from the PLC to the terminal

Concerns the following commands :

- Display an application page,
- Display alarm pages,
- Lock keys,
- Enter request for a variable field,
- Print command,
- Control of indicator lamps associated with function keys,
- Clear log command,
- Set real-time clock command.

Status data from the terminal to the PLC

Concerns the following states :

- The terminal status
 - . confidential mode,
 - . terminal configuration mode,
 - . confirmation of entries via ENTER key,
 - . abandon entry via ESC key,
 - . abandon entry after a time-out,
- Number of displayed page,
- Number of last field entered,
- Image of keypad keys,
- Real-time clock status (date and time),
- Occupancy rate of log as a percentage,
- Communication monitoring,
- Number of last alarm acknowledged.

3. Principle of exchanging data associated with fields

The exchange principle depends on the protocol chosen according to the type of PLC,

The terminal may be master or slave, client or server of the dialogue.

The terminal is most commonly the client, and is responsible for the following exchanges :

- updating of fields (reading values in the PLC)
- entry and modification of fields (writing of values to the PLC)

No communication program needs to be written.

D

4. Principle of the dialogue table

To simplify the dialogue, all data :

- Commands from the PLC to the terminal
- Status data from the terminal to the PLC

are grouped together in a table : **the dialogue table**.

Composed of n consecutive words (words of 16 bits), this table has 2 parts

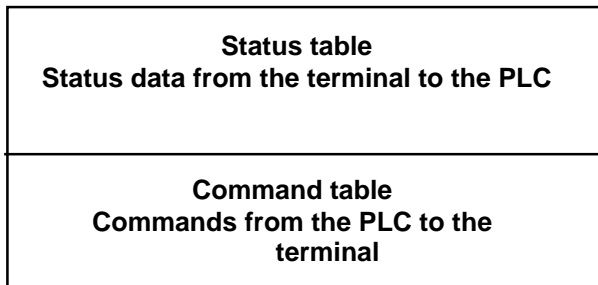

The number of words in the table depends on the choice of status data and commands that are to be processed via the dialogue.

The XBT-L1000 software is used to make this choice.



Using the "Authorisation" word is a safety check for the PLC.

If this word is not at the correct value, the terminal cannot write any word to the PLC.

- The authorisation word is not compulsory.
- It is systematically present in the dialogue table offered by XBT-L1000.
- It is strongly advisable to retain the authorization word in the dialogue table as long as the table contains at least one word to be written by the XBT.

The dialogue table is in the PLC (n consecutive words).
 The terminal reads and writes the table to the PLC.
 There is no PLC programme to write for the communication part.

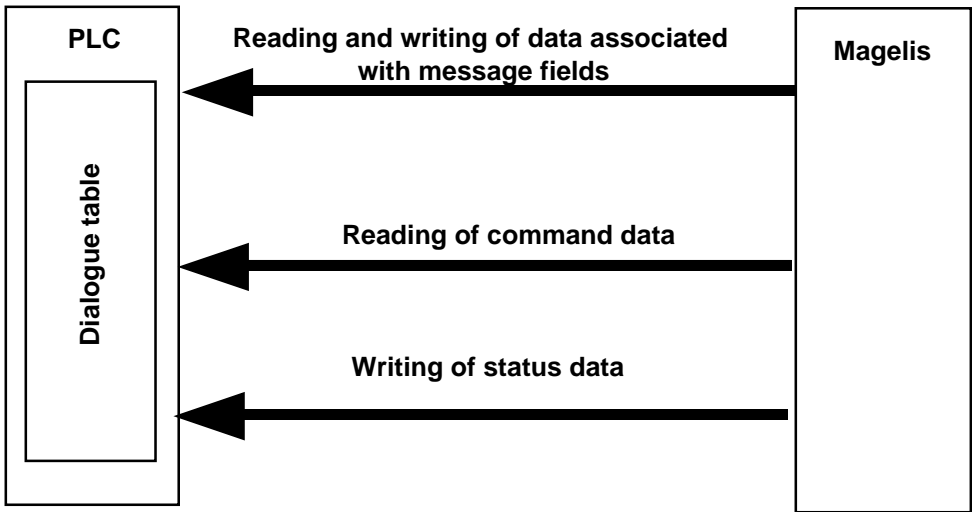

When the terminal is switched on or communication restarted, it reads the command table and writes the status table. In the event of a problem the terminal informs the user via a message.

5. Contents of the dialogue table

The number of words in the table depends on the choice of states and commands that are to be processed via the dialogue.

Notation convention for describing the table

W_n word of 16 bits

W_n, i : bit i of word n

The address n is taken as the start of table address.

The table comprises : a maximum of 46 words.

The description below gives the content of the various dialogue table words. Refer to the XBT-L1000 software on-line help for more information on the words.

Dialogue table

Wn+0 to Wn+1	Function keys	PLC <- XBT
Wn+2	System keys	PLC <- XBT
Wn+3	Numeric keys	PLC <- XBT
Wn+4	Communication control	PLC <- XBT
Wn+5 to Wn+8	Set PLC clock	PLC <- XBT
Wn+9	Number of displayed page	PLC <- XBT
Wn+10	Number of last field entered	PLC <- XBT
Wn+11	Last alarm acknowledged	PLC <- XBT
Wn+12	Confirmation report	PLC <- XBT
Wn+13	Log occupancy rate	PLC <- XBT
Wn+14	Number of page to be processed	PLC<->XBT
Wn+15	Field to be entered	PLC<->XBT
Wn+16	Print command	PLC<->XBT
Wn+17	Authorisation	PLC -> XBT
Wn+18	Reset log	PLC -> XBT
Wn+19 to Wn+20	LED commands	PLC -> XBT
Wn+21 to Wn+22	Lock function keys	PLC -> XBT
Wn+23	Lock system keys	PLC -> XBT

Wn+24	Lock numeric keys	PLC -> XBT
Wn+25 to Wn+40	Alarm table	PLC -> XBT
Wn+41 to Wn+45	PLC date and time to terminal	PLC -> XBT
Wn+46	Printout table in free format (maximum of 40 words on one line of printout)	PLC -> XBT

Detailed description

Wn to Wn+3: Images of terminal keypad keys to PLC.
Bit at 1= key pressed

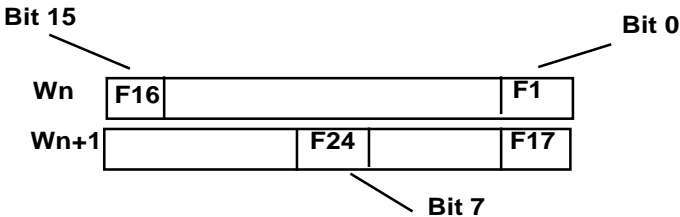

See field E for the key positions on the terminal

Wn+2

- Bit 0: Up arrow
- Bit 1: Down arrow
- Bit 2: Right arrow
- Bit 3: Left arrow
- Bit 4: MOD
- Bit 5: PRINT
- Bit 6: MENU
- Bit 7: SYST
- Bit 8: ALARM
- Bit 9: EXIT
- Bit 10: HOME
- Bit 11: +1
- Bit 12: -
- Bit 13: ENTER
- Bit 14:
- Bit 15:

Wn+3

- Bit 0: 0
- Bit 1: 1
- Bit 2: 2
- Bit 3: 3
- Bit 4: 4
- Bit 5: 5
- Bit 6: 6
- Bit 7: 7
- Bit 8: 8
- Bit 9: 9
- Bit 10: .
- Bit 11: +/-
- Bit 12: LED
- Bit 13:
- Bit 14:
- Bit 15:

Wn+4 : Communication control

Word incremented by 1 at each communication request by the terminal. It is sent to the PLC. This monitors the communication between the terminal and PLC.

Wn+5 to Wn+8: Terminal date and time to be sent to the PLC.

MWn+5	Seconds	Reserved
Wn+6	Hours	Minutes
Wn+7	Months	Day of month
Wn+8	Century	Year

Only XBT-E possesses a protected real-time clock. The XBT writes the time and date periodically to the PLC (approximately every second).

2 coding formats are possible:

Hexadecimal or BCD (option selected with XBT-L1000).

Wn+9 : Number of page to be displayed

N° of the page displayed on the terminal and to be sent to the PLC. It contains H'FFFF' if it is a system page or a displayed alarm.

Wn+10 : Number of last field entered

N° of last field entered on the terminal to be sent to the PLC.

Wn+11 : Last alarm accepted

This information is only present on one PLC scan, it then returns to H'FFFF'.

Wn+12 : Confirmation report

- Bit 0: Confidential mode
- Bit 1: Configuration mode
- Bit 2: ENTER on entry
- Bit 3: ESC on entry
- Bit 4: End of entry on TIME-OUT (1 mn)
- Bit 5: Reserved
- Bit 6: Printing fault
- Bit 7: Reserved
- Bit 8: Reserved
- Bit 9: Reserved
- Bit 10: Reserved
- Bit 11: Reserved
- Bit 12: Reserved
- Bit 13: Reserved
- Bit 14: Reserved
- Bit 15: Reserved

Wn+13 : Log occupancy rate

The occupancy rate of the alarm log as a % on the terminal and to be sent to the PLC.

Wn+14 : Page number to be processed

To process page 22 insert 22 -> Wn+14

When Wn+9 = 22 and Wn+14 = H'FFFF' the command is OK

When Wn+9 < > 22 and Wn+14 = H'FFFF' the command is not OK

Wn+15 : Field to enter

If the field 20 is to be entered on page 10 :

* confirm that Wn+9 = 10

* then 20 -> Wn+15

When Wn+10 = 20 and Wn+15 = H'FFFF' the command is OK.

Wn+12 then gives more detail : "ENTER on entry".

When Wn+10 < > 20 and Wn+15 = H'FFFF' the command is not OK

Wn+12 then gives more detail : "ESC Time-out".

Wn+16 : Print command

MSB : Print code	LSB : Long Tab
------------------	----------------

A code is assigned to each possible print type.

- free format print: 01
- print sheet: 04 (page No. 0 to 255)
- print log: 02
- application page printout: 05 (page No. 0 to 255)

For free format printing, the PLC gives the **length in bytes** of the information to be printed (maximum 40 words) in the LSB. The terminal then reads the length given in the print table in dialogue mode. To print out sheets, the LSB represents the sheets numbers.

The word "Print command" is written by the PLC.

This same word is written to H'FFFF' by the XBT, to acknowledge the end of the command.

Wn+17 : Authorisation

MSB	LSB
-----	-----



For a table 20 words long, the PLC can write to the authorisation word H'A514'. (A5= authorisation, 14= Nbr of words in dialogue table in Hexadecimal).

Wn+18 : Reset log

The PLC writes H'00FF' in this word.

- the XBT clears the log and resets the "log occupancy rate" (Wn+13).
- the PLC must writes H'0000' in the word Wn+18 to accept a new Reset log command.

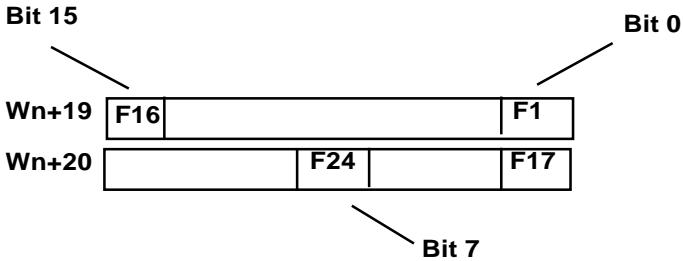
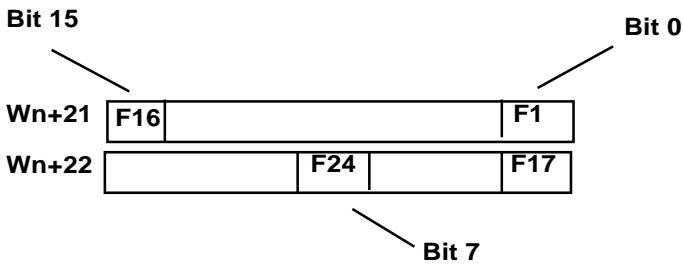
Wn+19 to Wn+20: LED control**Wn+21 to Wn+22 : Lock function keys****Wn+23 : Lock system keys****Wn+23**

- Bit 0: Up arrow
- Bit 1: Down arrow
- Bit 2: Right arrow
- Bit 3: Left arrow
- Bit 4: MOD
- Bit 5: PRINT
- Bit 6: MENU
- Bit 7: SYST
- Bit 8: ALARM
- Bit 9: ESC
- Bit 10: HOME
- Bit 11: +1
- Bit 12: -1
- Bit 13: ENTER
- Bit 14:
- Bit 15:

Wn+24 : Lock numeric keys

Wn+24

- Bit 0: 0
- Bit 1: 1
- Bit 2: 2
- Bit 3: 3
- Bit 4: 4
- Bit 5: 5
- Bit 6: 6
- Bit 7: 7
- Bit 8: 8
- Bit 9: 9
- Bit 10: .
- Bit 11: +/-
- Bit 12: LED
- Bit 13:
- Bit 14:
- Bit 15:

Wn+25 to Wn+40 : Alarm table

Command to display alarm pages

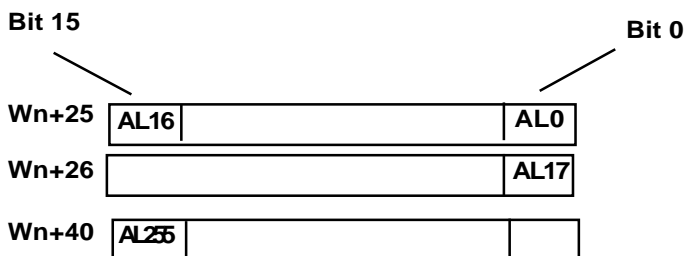

Wn+41 to Wn+44 : PLC date and time to be sent to the Terminal.

Wn+41	Seconds	Reserved
Wn+42	Hours	Minutes
Wn+43	Month	Day of month
Wn+44	Century	Year

Only the XBT-E has a protected real-time clock.

Each time one of these words is modified, the XBT sets itself to the date and time given in this table.

2 coding formats are possible:

Hexadecimal or BCD (option selected with XBT-L1000).

Wn+45 : Free format printing table (up to 40 words)

see print command.



Section E

XBT technical sheets

This section describes the detailed characteristics of each XBT :

1. XBT-H	E-5
2. XBT-HM	E-9
3. XBT-P	E-13
4. XBT-E	E-17

1. XBT-H

XBT-H002010, XBT-H001010 front panel.

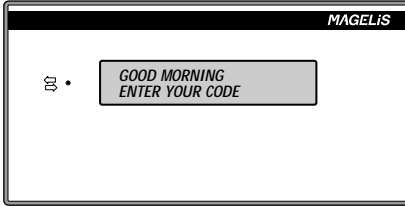

XBT-H021010, XBT-H020010 front panel.

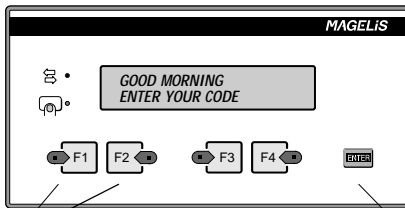

Function keys

Service keys

XBT-H011010, XBT-H012010, XBT-H012110 front panel.

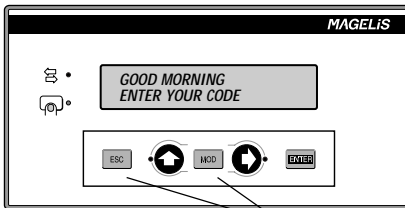

Service keys

XBT-H811050 front panel.

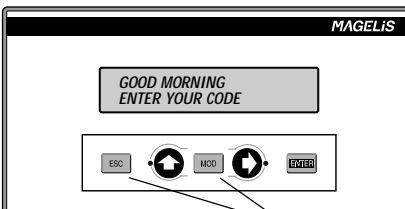

Service keys



Display unit types	<p>*XBT-H811050: no back-lit LCD (5*7 pixels), XBT-H0.1010 : back-lit LCD (5*7 pixels), height 9 mm.</p> <p>XBT-H0.2.10 Fluorescent green matrix for each character (5*7 pixels), height 5 mm.</p>
Serial link	RS232/RS485/RS422 asynchronous serial link.
Data exchange protocol	<p>Can be remotely loaded from the protocol diskette using XBTL-1000 software.</p> <p>Protocol : Uni-Telway, Modbus, Jbus, Siemens, Allen Bradley, Omron, Modicon KS... .</p> <p>*XBT-H811050 UNI-TE protocol only.</p>
Memory	<p>128 kb Flash EEPROM, capacity of approximately 200 application pages. Up to 256 alarm pages, depending on page distribution. 256 kb Flas EEPROM on XBT-H01XXXX.</p> <p>*XBT-H811050:100 application pages, 128 alarm pages.</p>
Language version	English, French, Spanish, Italian, German
Weight	0.600 Kg / 1,323 lbs
Temperature	<p>Operation : 0 to 50°C (32,0° to 122,0° F) Humidity 85%.</p> <p>Storage :</p> <ul style="list-style-type: none"> - 40° + 70°C (-40+158°F) for a fluorescent display - 20° + 60°C (-4 +140°F) for an LCD display
Power supply	<p>*XBT-H811050: TSX07 supply (use XBT-Z968 cable). XBT-H0XXXXX:</p> <p>24VDC</p> <p>Limits : 18 to 30VDC</p> <p>Ripple : 5% max</p> <p>Consumption : 10W (*XBT-H811050 : 1,5 W)</p>
Degree of protection	IP65 according to IEC529 and degree1 NFC20-010 UL Type 4,4x, Nema 4
Mounting and fixing	Flush mounted, fixed by 8 pressure mounted bolts supplied on a 1 to 6 mm thick panel.

Specific characteristics

Terminal	XBT-H002010 XBT-H001010	XBT-H021010 XBT-H022010	XBT-H011010 XBT-H012010 XBT-H012110	*XBT-H 811050
Display	2 lines of 20 characters			
Function keys	0	4	0	0
Service keys	0	1	5	5
Numeric keys	0	0	0	0
Alphanumeric keys	0	0	0	0
Signalling DEL	Communication	- Communication - Return key - Function key 4 : - Service key : 0	- Communication - Return key - Function key: 0 - Service key: 2	None
Printer link	No	No	RS232 asynchronous serial link for XBT-H012110	No
Real-time clock	Acces to PLC real-time clock			

2. XBT-HM

XBT-HM007010 front panel

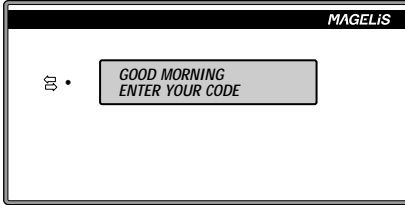

XBT-HM027010 front panel

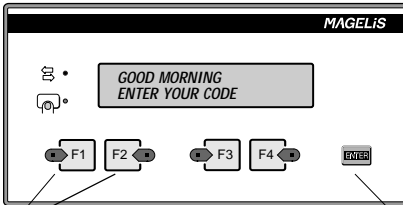

Function keys

Service keys

XBT-HM017010 and XBT-HM 017110 front panel

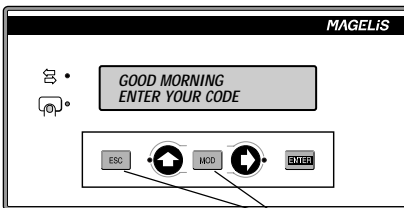

Service keys



Type of display	Matrix LCD monochrome (240*64 pixels), 8*40 characters with possibility of: - 4*40 characters (double height) - 8*20 characters (double width) - 4*20 characters (double size)
Serial link	RS232/RS485/RS422 asynchronous serial link
Data exchange protocol	Can be downloaded from protocol diskette using XBT-L1000 software. Protocols : Uni-Telway, Modbus, Jbus, Siemens, Allen Bradley, Omron, Modicon KS....
Memory	384 kb Flash EPROM, giving a capacity of approximately 300 application pages. The maximum number of alarm pages is 256 depending on page distribution.
Language version	French, English, Spanish, Italian, German
Weight	0.600 Kg / 1.1 lbs
Temperature	Operation : 0 to 50°C (32 to 122°F), humidity 0 to 85% Storage : - 20° to + 60° C (-40 to +140 °F)
Power supply	24 VDC Limits : 18 to 30 VDC Ripple : 5% max Consumption : 15 W
Degree of protection	IP65 to IEC529 and degree 1 to NFC20-010 UL Type 4,4x, Nema 4
Mounting and fixing	Flush mounted, attached by 6 spring clips to a 1 to 6 mm thick panel.

Specific characteristics

Terminal	XBT-HM007010	XBT-H027010	XBT-HM017010 XBT-HM017110
Function keys	0	4	0
Service keys	0	1	5
Signalling: LED	- communication	- communication - return key - function key: 4 - service key: 0	- communication - return key - function key: 0 - service key: 2
Printer link	No	No	RS232 asynchronous serial link for XBT-H017110
Real time clock	Access to PLC real time clock		



3. XBT-P

XBT-P011010, XBT-P012010 front panel.

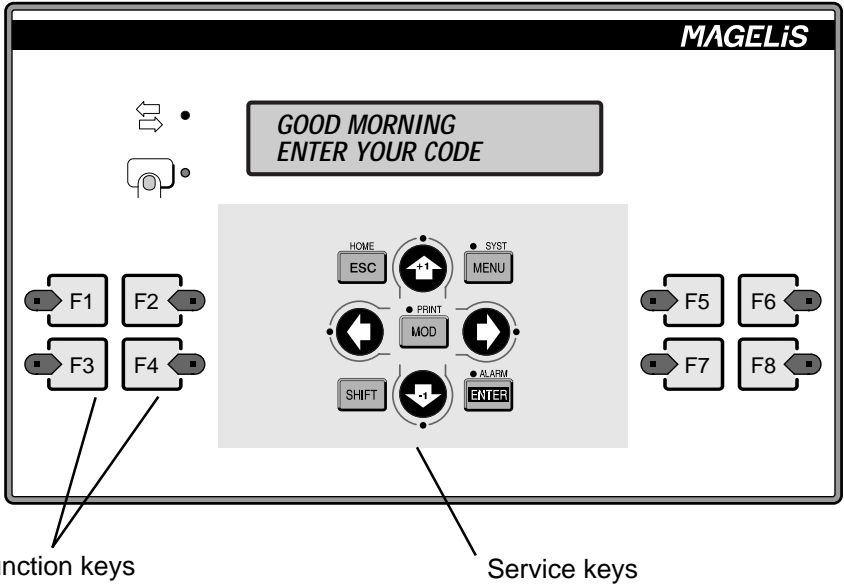

XBT-P021010, XBT-P022010, XBT-P022110,
XBT-P021110 front panel.

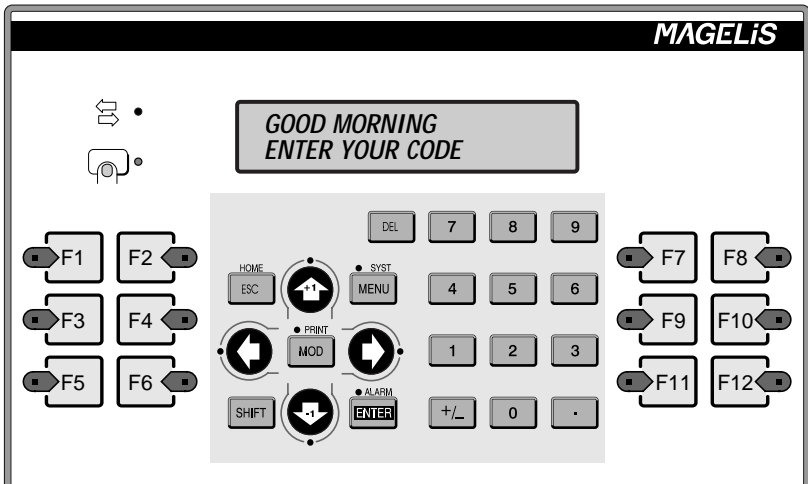

Type of display unit	.XBT-P0.1.10 back lit LCD (5*7 pixels), height 9 mm. XBT-P0.2.10 : Fluorescent green matrix for each character (5*7 pixels), height 5 mm.
Serial link	RS232/RS485/RS422 asynchronous serial link
Data exchange protocol	Can be remotely loaded from diskette using XBTL-1000 software. Protocol : Uni-Telway, Modbus, Jbus, Siemens, Allen Bradley, Omron...
Memory	256 kb Flash EPROM, capacity of approximately 400 application pages. Up to 256 alarm pages, depending on page distribution.
Language version	English, French, Spanish, Italian, German
Weight	0,800 kg / 1,985 lbs
Temperature	Operation : 0 to 50°C (32,0° to 122,0° F) Humidity 85%. Storage : - 40° + 70°C (-40+158°F) for a fluorescent display - 20° + 60° C (-4 + 140°F) for a LCD display
Power supply	24VDC Limits : 18 to 30VDC Ripple : 5% max Consumption : 10W
Degree of protection	IP65 according to IEC529 and degree1 NFC20-010 UL Type 4,4x, Nema 4
Mounting and fixing	Flush mounted, fixed by 8 pressure mounted bolts on a 1 to 6 mm panel.

Specific characteristics

Terminal	XBT-P011010 XBT-P012010	XBT-P021010 XBT-P022010	XBT-P021110 XBT-P022110
Display	2 lines of 20 characters	2 lines of 20 characters	2 lines of 20 characters
Function keys	8	12	12
Service keys	9	10	10
Numeric keys	0	12	12
Alphanumeric keys	0	0	0
Signalling	Communication LED Return key LED Function key : 8 LED Service key : 7 LED	Communication LED Return key LED Function key : 12 LED Service key : 7 LED	Communication LED Return key LED Function key : 12 LED Service key : 7 LED
Printer link	No	No	RS232 asynchronous serial link
Real-time clock	Access to PLC real-time clock	Access to PLC real-time clock	Access to PLC real-time clock

4. XBT-E

XBT-E013010, XBT-E014010, XBT-E013110,
XBT-E014110 front panel.

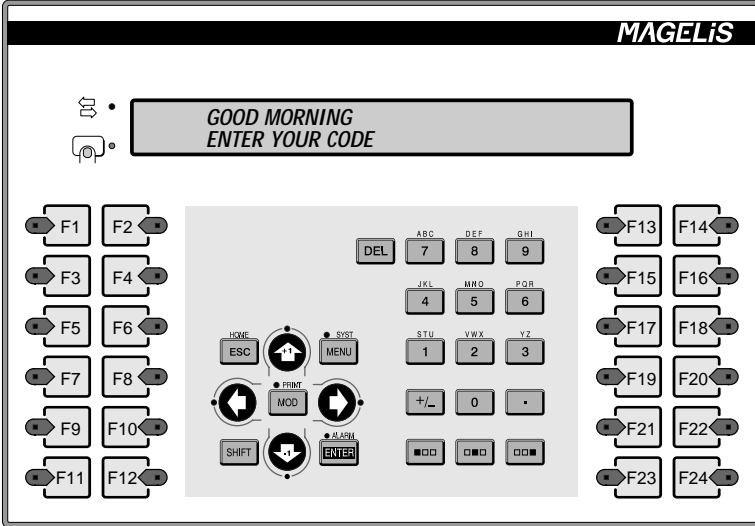

XBT-E015010, XBT-E016010, XBT-E015110,
XBT-E016110 front panel.

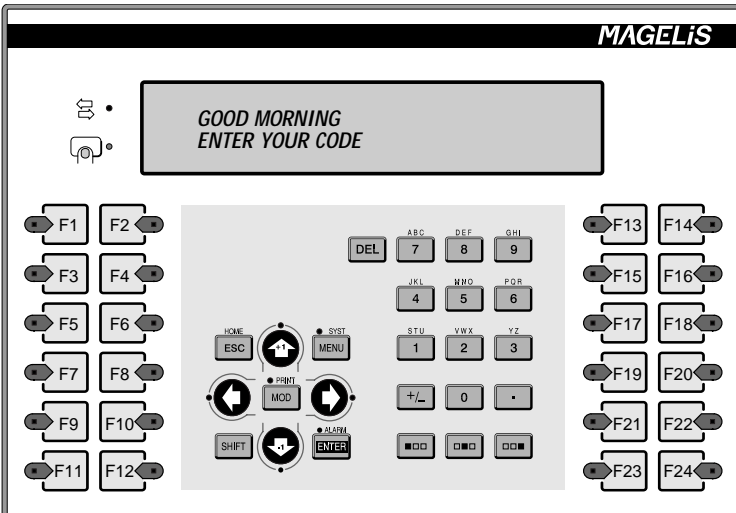

Display type	XBT-E013.10, XBT-E015.10 : back lit LCD (5*7 pixels), height 5 mm. XBT-E014.10,XBT-E016.10 : Fluorescent green matrix for each character (5*7 pixels), height 5 mm.
Serial link	RS232/RS485/RS422 asynchronous serial link
Data exchange protocol	Can be remotely loaded from protocole diskette using XBTL-1000 software. Protocols: Uni-Telway, Modbus, Jbus, (Siemens, Allen Bradley,Omron...).
Memory	384 kb Flash EEPROM - for 2 lines per page, approximately 800 application pages. Up to 256 alarm pages, depending on page distribution. - for 4 lines per page, approximately 400 application pages. Up to 128 alarm pages, depending on page distribution.
Language version	English, French, Spanish, Italian, German
Weight	1,3 kg / 2,866 lbs
Temperature	Operation : 0 to 50°C (32,0° to 122,0°F) Humidity 85%. Storage : - 40° + 70°C (-40+158°F) for a fluourescent display - 20° + 60°C (-4 +140°F) for an LCD display
Power supply	24VDC Limits : 18 to 30VDC Ripple : 5% max Consumption : - 10 W (LCD display) - 20 W (fluourescent display)
Degree of protection	IP65 according to IEC529 and degree1 NFC20-010 UL Type 4,4x, Nema 4
Mounting and fixing	Flush mounted, fixed by 10 pressure mounted bolts on a 1 to 6 mm panel.

Specific characteristics

Terminal	XBT-E013010 XBT-E014010 XBT-E013110 XBT-E014110	XBT-E015010 XBT-E016010 XBT-E015110 XBT-E016110
Display	2 lines of 40 characters	4 lines of 40 characters
Function keys	24	
Service keys	10	
Numeric keys	12	
Alphanumeric keys	15	
Signalling	Communication LED, return key LED Function key : 24 LED, service key : 7 LED	
Printer link	XBT-E013110, XBT-015110 XBT-E014110, XBT-E016110 RS232 asynchronous serial link	
Real-time clock	Yes	
Alarm relay	1 mA / 5V mini AC / DC 0.5A/24V maxi AC / DC (to command relay (see page C-31 §7.5))	

Section F
Glossary

F

Alarm page

Page displayed after a control system fault.

Application page

Page displayed to monitor and control the control system.

Commands table

Part of the dialogue table filled in by the PLC (orders passed to the terminal).

Confidential mode

Mode allowing access to all operation functions of the terminal and connected functions.

Dialogue table

Table of words containing all the information necessary for Magelis terminal control and operation.

JBUS master

Device which requests J-BUS functions (write or read).

JBUS slave

Device responding to the requests of a J-BUS master.

Links

Association between application pages.

Recording mode

Mode used for XBT-L1000<-> MAGELIS exchanges.

Status table

Part of the dialogue table filled in by the terminal (terminal status).

UTW client

Device which requests UNI-TE services, i.e. is capable of sending UNI-TE requests.

UTW server

Device responding to requests for UNI-TE services from client devices.

Variable field

Zone of an XBT display unit configured to display and/or modify a piece of information depending on the value of an object in the connected control system.

XBT application

Set of data describing the man/machine dialogue with a Magelis terminal.

XBT-L1000

Software for creating man/machine dialogue applications.

Section G
Index

G

A	Pages
Acceptance of alarms	C-30
Alarm pages	A-16
Alarm relay	C-31
Alarms	C-25
Application	A-7
Application pages	A-11
Assigning function keys	C-41
Authorisation word	D-14
C	
Characteristics	A-23
Clear log	C-37
Client	D-9
Command table	D-8
Confidential mode	C-16
Configuration	C-48
Control of alarm relay	C-31
D	
Dialogue table : contents	D-10
Dialogue table : objective	D-8
Display priority	C-28
Display when switched on	C-17
Displaying a page via its name	C-18
Displaying a page via its number	C-18
Displaying the log	C-35
E	
Entering parameters	C-21
F	
Fields	A-9
Function keys	C-40
Forms	C-54
I	
Indicator lamps	C7

K	
Keys	C-7
L	
Language	C-42
Links	A-10
Locking function keys	C-42
Log	C-34
Log display	C-35
M	
Master	D-7
Modifying parameters	C-21
Momentary contact command	C-40
N	
Numbered list	C-24
P	
Page display via a function key	C-20
Page display via the PLC	C-20
Password	C-17
PC link	A-24
PLC link	A-24
Power-up	A-24
Printer link	C-6
Printing	C-38
Print log	C-44
Process control	C-40
Protocol	D-7
Push on / push off command	C-40

R	
Real-time clock	C-49
Recording mode	C-12
Running mode	C-13
S	
Server	D-7
Status table	D-8
Self-tests	C-52
X	
XBT-E	E-17
XBT-HM	E-9
XBT-H	E-5
XBT-P	E-13

Section H

Error messages

H



System messages generated by the XBT (system messages in English only), which cannot be configured.

WIRING FAULT

SWITCH POWER OFF : Incorrect wiring.

WAITING FOR TRANSFER : Awaiting remote loading.

NO PROGRAM : Product has no application (Version 1.1).

NO APPLICATION : Product has no application (Version 2.1).

DOWNLOAD IN PROGRESS : Download to the XBT in progress.

DOWNLOAD ABORTED : Download to the XBT cancelled by the operator.

DOWNLOAD FAILED : Download to the XBT failed.

DOWNLOAD COMPLETED : Download to the XBT finished.

UPLOAD IN PROGRESS : Upload to the PC in progress.

UPLOAD ABORTED : Upload to the PC cancelled by the operator.

UPLOAD FAILED : Upload to the PC failed.

UPLOAD COMPLETED : Upload to the PC finished.

CONNECTING : Reading the cable and searching for the communication configuration in progress.

APPLICATION FAULT : Application error (incoherence).



System messages generated by the XBT in 5 languages (language selected during configuration).

WRONG PASSWORD : Entry of an incorrect password.

PAGE DOES NOT EXIST: Call-up of a non-existent page.

PROTECTED ACCESS PAGE : Call-up of a protected page.

IMPOSSIBLE TO WRITE VARIABLE IN PLC : A variable is written to a protected zone.

OVERFLOW MIN <= VALUE <= MAX : Entry of a value which is outside the limits.

DIALOG TABLE AUTHORIZ. : Authorisation word is incorrect.

DIALOG TABLE READING IMPOSSIBLE : Connection problems between XBT <-> PLC.

DIALOG TABLE WRITING IMPOSSIBLE : Writing to a protected zone or XBT <-> PLC connection problems.

PRINTING IMPOSSIBLE: Transient display if printing is possible, after having selected an option.

PRINTING IMPOSSIBLE : Transient display when printing is in progress.

FAULTY PRINTER: Transient display when printer is faulty.

EMPTY LOG: Transient message, the log display is empty when the operator request display or printing.

ACCESS PROHIBITED : Fleeting display if the action is prohibited after one of the options has been selected.

DATA NOT ACCESSIBLE : Fleeting display after a non-authorized variable has been entered.

PAGE NOT ACCESSIBLE : Fleeting display after a nonexistent page has been called.

MASTER FAULT : Special case of a server protocol when the client is in fault condition.





Les produits, matériels et services présentés dans ce document sont à tout moment susceptibles d'évolutions quant à leurs caractéristiques de présentation, fonctionnement ou utilisation. Leur description ne peut en aucun cas revêtir un aspect contractuel.

© Copyright Telemecanique 1995. Toute reproduction de cet ouvrage est interdite. Toute copie ou reproduction, même partielle, par quelque procédé que ce soit, photographique, magnétique ou autre, de même que toute transcription totale ou partielle lisible sur machine électronique est interdite.